

2020 ÜRÜN KATALOĞU ve FİYAT LİSTESİ



ABS ve POLİKARBONAT PANOLAR



SİRAL BORU ve AKSESUARLARI

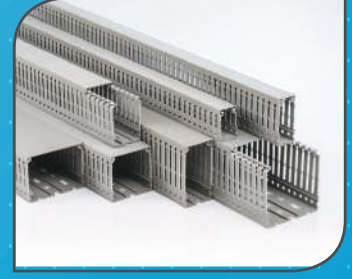

DELİKLİ KABLO KANALLARI



TERMOSTATLAR



FİLTRELİ FANLAR



PANO ISITICILARI



PANO KLİMALARI



KABLO BAĞLARI



BUTONLAR ve AKSESUARLARI



İZOLELİ KABLO UÇLARI



DAĞITICI ÜNİTELER



DIN RAYLARI ve RAY TAŞIYICI

YENİ ÜRÜNLER



SPIRAL BORULAR



SPIRAL BORU AKSESUARLARI



KABLO BAĞLARI



RAY TİPİ PANO PRİZİ

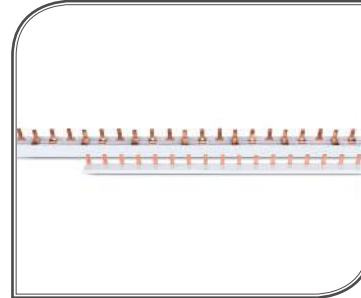

MÜŞTEREK OTOMAT BARALARI



TERMoeLEKTRİK SOĞUTUCULAR



DAĞITICI ÜNİTELER



SLİM ISITICI



PFHT PLASTİK FANLI ISITICI



PET KABLO ÇORAPLARI



MEKANİK VE HİDROLİK EL ALETLERİ



ALÜMİNYUM PRİZ BLOKLARI

İÇİNDEKİLER

POLYAMİD ve POLİPROPİLEN SİRAL BORULAR.....	5
POLYAMİD SİRAL BORU RAKORLARI.....	6
POLYAMİD SİRAL BORU AKSESUARLARI.....	7
KABLO BAĞLARI.....	8-9
KABLO BAĞI AKSESUARLARI.....	10
MÜŞTEREK OTOMAT BARALARI.....	11
ABS ve POLİKARBONAT PANOLAR.....	12
ABS ve POLİKARBONAT DAĞITIM PANOLARI.....	13
ABS PANO AKSESUARLARI.....	14
DELİKLİ KABLO KANALLARI.....	15-16
DELİKLİ KANAL AKSESUARLARI.....	17
PANO İKLİMLENDİRME ÜRÜNLERİ.....	20-21
PANO İÇİ TERMOSTAT HİGROSTAT.....	22
DİJİTAL TERMOSTAT HİGROSTAT.....	23
TERMoeLEKTRİK SOĞUTUCULAR.....	24
PANO KLİMALARI.....	25
DAĞITICI ÜNİTELER.....	26-27
PANO ISITICILARI.....	28-29
SIKMALI KABLO PAPUÇLARI.....	30-31
DIN RAYLARI VE RAY TAŞIYICI.....	32
PET KABLO ÇORAPLARI.....	33
PFI SERİSİ KOLAY MONTAJLI FİLTRELER.....	35
FİLTRELİ FANLAR.....	36-43
ENDÜSTRİYEL FANLAR.....	44-52
AKSESUARLAR.....	53
İZOLELİ KABLO UÇLARI.....	54-59
PBO SERİSİ BUTONLAR.....	61-63
PBO SERİSİ BUTON AKSESUARLARI.....	64
MEKANİK ve HİDROLİK EL ALETLERİ.....	65-67
ALÜMİNYUM PRİZ BLOKLARI.....	68

POLYAMİD ve POLİPROPİLEN SİRİRAL BORULAR



POLYAMİD ve POLİPROPİLEN SİRİRAL BORULAR



- Polyamid (PA6)
- Çalışma Sıcaklığı: -40°C... +120°C
- Koruma Sınıfı: IP 68
- Halogen Free
- Alev İletmez

POLYAMİD 6 SİRİRAL BORULAR (PA6)

ANMA ÇAPı	SİYAH KOD	GRİ KOD	İÇ ÇAP (mm)	DIŞ ÇAP (mm)	AMBALAJ (m)	FİYAT
9	PS-PA09B	PS-PA09G	10,0	13,0	100	0.50 €
11	PS-PA11B	PS-PA11G	12,0	16,0	50	0.69 €
13.5	PS-PA13.5B	PS-PA13.5G	14,0	18,5	50	0.77 €
16	PS-PA16B	PS-PA16G	17,0	21,5	50	0.97 €
21	PS-PA21B	PS-PA21G	23,0	28,7	50	1.37 €
29	PS-PA29B	PS-PA29G	29,0	34,5	25	1.80 €
36	PS-PA36B	PS-PA36G	36,0	42,5	25	2.27 €
48	PS-PA48B	PS-PA48G	48,0	54,5	25	3.56 €



- Polipropilen (PP)
- Çalışma Sıcaklığı: -40°C... +95°C
- Koruma Sınıfı: IP 68

POLİPROPİLEN SİRİRAL BORULAR (PP)

ANMA ÇAPı	SİYAH KOD	GRİ KOD	İÇ ÇAP (mm)	DIŞ ÇAP (mm)	AMBALAJ (m)	FİYAT
9	PS-PP09B	PS-PP09G	10,0	13,0	100	0.29 €
11	PS-PP11B	PS-PP11G	12,0	16,0	50	0.31 €
13.5	PS-PP13.5B	PS-PP13.5G	14,0	18,5	50	0.41 €
16	PS-PP16B	PS-PP16G	17,0	21,5	50	0.45 €
21	PS-PP21B	PS-PP21G	23,0	28,7	50	0.63 €
29	PS-PP29B	PS-PP29G	29,0	34,5	25	0.76 €
36	PS-PP36B	PS-PP36G	36,0	42,5	25	0.99 €
48	PS-PP48B	PS-PP48G	48,0	54,5	25	1.61 €

POLYAMİD SİRİRAL BORU AKSESUARLARI

PG DİŐ GEÇMELİ TİP RAKORLAR



SİYAH KODU	GİRİ KODU	SİRİRAL KODU	SİRİRAL ÖLÇÜ (mm)	KUTU ADEDİ	FİYAT
PD10-PG7B	PD10-PG7G	PA7	6.5x10	100	0.38 €
PD12-PG7B	PD12-PG7G	PA8.5	8.5x12	75	0.38 €
PD13-PG9B	PD13-PG9G	PA9	10x13	50	0.39 €
PD15-PG11B	PD15-PG11G	PA11	12x15.8	50	0.45 €
PD18-PG13.5B	PD18-PG13.5G	PA13.5	14.2x18.4	75	0.52 €
PD21-PG16B	PD21-PG16G	PA16	16.5x21.2	50	0.65 €
PD28-PG21B	PD28-PG21G	PA21	23.5x28.4	25	1.05 €
PD34-PG29B	PD34-PG29G	PA29	29x34.5	20	1.35 €
PD42-PG36B	PD42-PG36G	PA36	36x42.5	15	1.86 €
PD54-PG48B	PD54-PG48G	PA48	48x54.5	10	2.50 €

- Polyamid (PA)
- Çalışma Sıcaklığı: -40°C... +105°C
- Halogen Free
- Alev İletmez

METRİK DİŐ GEÇMELİ TİP RAKORLAR



SİYAH KODU	GİRİ KODU	SİRİRAL KODU	SİRİRAL ÖLÇÜ (mm)	KUTU ADEDİ	FİYAT
PD10-M12B	PD10-M12G	PA7	6.5x10	100	0.39 €
PD12-M12B	PD12-M12G	PA8.5	8.5x12	75	0.39 €
PD13-M16B	PD13-M16G	PA9	10x13	50	0.43 €
PD15-M16B	PD15-M16G	PA11	12x15.8	50	0.51 €
PD18-M20B	PD18-M20G	PA13.5	14.2x18.4	75	0.58 €
PD21-M20B	PD21-M20G	PA16	16.5x21.2	50	0.76 €
PD28-M25B	PD28-M25G	PA21	23.5x28.4	25	1.22 €
PD34-M32B	PD34-M32G	PA29	29x34.5	20	2.05 €
PD42-M40B	PD42-M40G	PA36	36x42.5	15	2.80 €
PD54-M63B	PD54-M63G	PA48	48x54.5	10	3.70 €

- Polyamid (PA)
- Çalışma Sıcaklığı: -40°C... +105°C
- Halogen Free
- Alev İletmez

POLYAMİD SİRİRAL BORU AKSESUARLARI

PG DİŐ GEÇMELİ TİP 90 DERECE DİRSEK RAKORLAR



SİYAH KODU	GRİ KODU	SİRİRAL KODU	SİRİRAL ÖLÇÜ (mm)	KUTU ADEDİ	FİYAT
PDD10-PG7B	PDD10-PG7G	PA7	6.5x10	75	1.50 €
PDD13-PG9B	PDD13-PG9G	PA9	10x13	50	1.70 €
PDD15-PG11B	PDD15-PG11G	PA11	12x15.8	50	1.84 €
PDD18-PG13.5B	PDD18-PG13.5G	PA13.5	14.2x18.4	50	2.23 €
PDD21-PG16B	PDD21-PG16G	PA16	16.5x21.2	40	2.60 €
PDD28-PG21B	PDD28-PG21G	PA21	23.5x28.4	25	2.98 €
PDD34-PG29B	PDD34-PG29G	PA29	29x34.5	15	6.35 €
PDD42-PG36B	PDD42-PG36G	PA36	36x42.5	5	8.60 €
PDD54-PG48B	PDD54-PG48G	PA48	48x54.5	5	10.72 €

- Polyamid (PA)
- Çalışma Sıcaklığı: -40°C... +105°C
- Halogen Free
- Alev İletmez

POLYAMİD KAPAKLI KROŐELER



SİYAH KODU	GRİ KODU	SİRİRAL KODU	SİRİRAL ÖLÇÜ (mm)	KUTU ADEDİ	FİYAT
PDBK13	PDGK13	PA9	13.0	50	0.27 €
PDBK15	PDGK15	PA11	15.8	50	0.28 €
PDBK18	PDGK18	PA13.5	18.4	50	0.30 €
PDBK21	PDGK21	PA16	21.2	50	0.32 €
PDBK28	PDGK28	PA21	28.4	25	0.37 €
PDBK34	PDGK34	PA29	34.5	25	0.65 €
PDBK42	PDGK42	PA36	42.5	25	0.85 €
PDBK54	PDGK54	PA48	54.5	10	0.97 €

- Polyamid (PA)
- Çalışma Sıcaklığı: -40°C... +105°C
- Halogen Free
- Alev İletmez

KABLO BAĞLARI

- Nylon 66
- UL94-V2 Alev İletmez
- Halogen Free
- Max. Çalışma Sıcaklığı 85°C
- Made in Taiwan

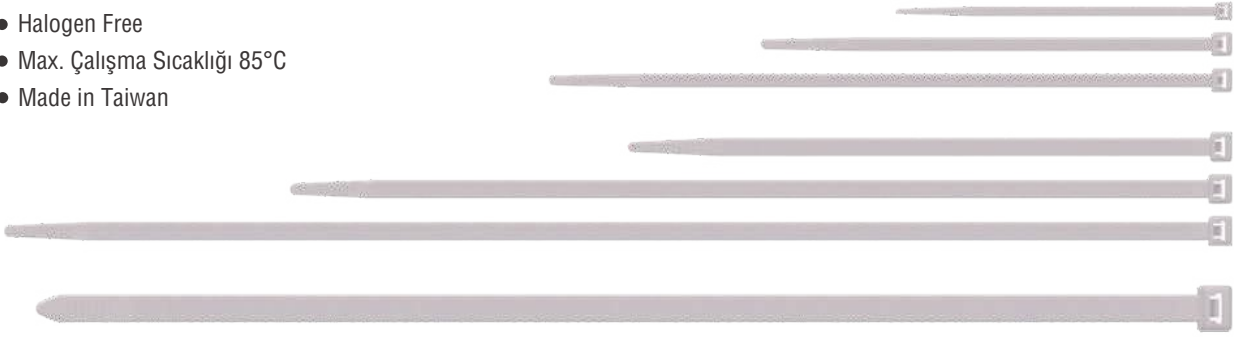

KABLO BAĞLARI BEYAZ

ÜRÜN KODU	ÖLÇÜ (mm)	RENK	BAĞLAMA ÇAPI (mm)	AÇILMA MUKAVEMETİ (kg)	PAKET	KOLİ	FİYAT
PKB-100M	2.5x100	BEYAZ	22	8	100	45.000	0.035 TL
PKB-150M	2.5x150	BEYAZ	39	8	100	30.000	0.060 TL
PKB-200M	2.5x200	BEYAZ	55	8	100	22.000	0.080 TL
PKB-150I	3.6x150	BEYAZ	36	18	100	20.000	0.098 TL
PKB-200I	3.6x200	BEYAZ	52	18	100	13.000	0.130 TL
PKB-250I	3.6x250	BEYAZ	68	18	100	12.000	0.166 TL
PKB-300I	3.6x292	BEYAZ	82	18	100	13.000	0.203 TL
PKB-370I	3.6x368	BEYAZ	105	18	100	9.000	0.245 TL
PKB-190S	4.8x190	BEYAZ	49	22	100	12.000	0.170 TL
PKB-250S	4.8x250	BEYAZ	68	22	100	9.000	0.235 TL
PKB-300S	4.8x300	BEYAZ	83	22	100	8.500	0.275 TL
PKB-370S	4.8x368	BEYAZ	105	22	100	7.500	0.345 TL
PKB-430S	4.8x432	BEYAZ	125	22	100	7.500	0.438 TL
PKB-550S	4.8x550	BEYAZ	162	22	100	4.500	0.600 TL
PKB-300H	7.6x300	BEYAZ	80	55	100	4.000	0.525 TL
PKB-370H	7.6x370	BEYAZ	101	55	100	4.000	0.635 TL
PKB-450H	8.0x450	BEYAZ	128	55	100	3.000	0.800 TL
PKB-550H	8.0x550	BEYAZ	160	55	100	2.500	1.090 TL
PKB-710H	9.0x710	BEYAZ	209	80	100	1.800	1.780 TL
PKB-760H	9.0x762	BEYAZ	227	80	100	1.000	1.900 TL
PKB-920H	9.0x914	BEYAZ	275	80	100	1.500	2.220 TL

KABLO BAĞLARI

- Nylon 66
- UL94-V2 Alev İletmez
- Halogen Free
- Max. Çalışma Sıcaklığı 85°C
- Made in Taiwan



KABLO BAĞLARI SİYAH

ÜRÜN KODU	ÖLÇÜ (mm)	RENK	BAĞLAMA ÇAPI (mm)	AÇILMA MUKAVEMETİ (kg)	PAKET	KOLİ	FİYAT
PKB-100MB	2.5x100	SİYAH	22	8	100	45.000	0.035 TL
PKB-150MB	2.5x150	SİYAH	39	8	100	30.000	0.060 TL
PKB-200MB	2.5x200	SİYAH	55	8	100	22.000	0.080 TL
PKB-150IB	3.6x150	SİYAH	36	18	100	20.000	0.098 TL
PKB-200IB	3.6x200	SİYAH	52	18	100	13.000	0.130 TL
PKB-250IB	3.6x250	SİYAH	68	18	100	12.000	0.166 TL
PKB-300IB	3.6x292	SİYAH	82	18	100	13.000	0.203 TL
PKB-370IB	3.6x368	SİYAH	105	18	100	9.000	0.245 TL
PKB-190SB	4.8x190	SİYAH	49	22	100	12.000	0.170 TL
PKB-250SB	4.8x250	SİYAH	68	22	100	9.000	0.235 TL
PKB-300SB	4.8x300	SİYAH	83	22	100	8.500	0.275 TL
PKB-370SB	4.8x368	SİYAH	105	22	100	7.500	0.345 TL
PKB-430SB	4.8x432	SİYAH	125	22	100	7.500	0.438 TL
PKB-550SB	4.8x550	SİYAH	162	22	100	4.500	0.600 TL
PKB-300HB	7.6x300	SİYAH	80	55	100	4.000	0.525 TL
PKB-370HB	7.6x370	SİYAH	101	55	100	4.000	0.635 TL
PKB-450HB	8.0x450	SİYAH	128	55	100	3.000	0.800 TL
PKB-550HB	8.0x550	SİYAH	160	55	100	2.500	1.090 TL
PKB-710HB	9.0x710	SİYAH	209	80	100	1.800	1.780 TL
PKB-760HB	9.0x762	SİYAH	227	80	100	1.000	1.900 TL
PKB-920HB	9.0x914	SİYAH	275	80	100	1.500	2.220 TL

KABLO BAĞI AKSESUARLARI

KABLO BAĞI AKSESUARLARI



ÜRÜN KODU	ÜRÜN AÇIKLAMASI	AMBALAJ MİKTARI	FİYAT
PYK-1	YAPIŞKAN KROŞE 19x19 mm BEYAZ	100	0.280 TL
PYK-2	YAPIŞKAN KROŞE 28x28 mm BEYAZ	100	0.480 TL
PYK-1B	YAPIŞKAN KROŞE 19x19 mm SİYAH	100	0.280 TL
PYK-2B	YAPIŞKAN KROŞE 28x28 mm SİYAH	100	0.480 TL
PVK-1	VİDALI KROŞE 15x10x7 mm BEYAZ	100	0.150 TL
PVK-2	VİDALI KROŞE 23x16x10 mm BEYAZ	100	0.190 TL



KABLO İŞARETLEME SİSTEMLERİ

ÜRÜN KODU	KABLO KESİTİ	MAKARA	FİYAT
P-EC-0	0.50 - 1.00mm KABLolar İÇİN	1000	20.00 TL
P-EC-1	1.50 - 6.00mm KABLolar İÇİN	1000	20.00 TL
P-EC-2	4.00 - 16.00mm KABLolar İÇİN	500	20.00 TL
P-EC-3	10.00 - 25.00mm KABLolar İÇİN	350	20.00 TL

RAY TİPİ PANO PRİZİ

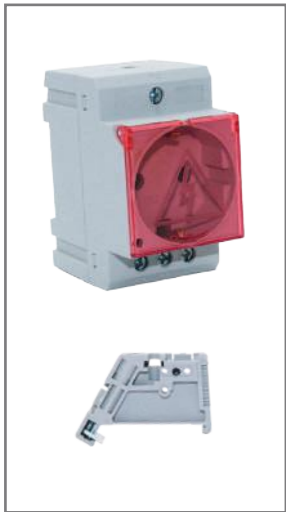

ÜRÜN KODU	ÜRÜN AÇIKLAMASI	AMBALAJ MİKTARI	FİYAT
PPR	16A RAY MONTAJ PANO İÇİ PRİZ	10	25.00 TL

RAY TİPİ DURDURUCU

ÜRÜN KODU	ÜRÜN AÇIKLAMASI	AMBALAJ MİKTARI	FİYAT
PKD-3	DIN-RAY TİPİ VİDALI DURDURUCU	50	3.50 TL

MÜŞTEREK OTOMAT BARALARI

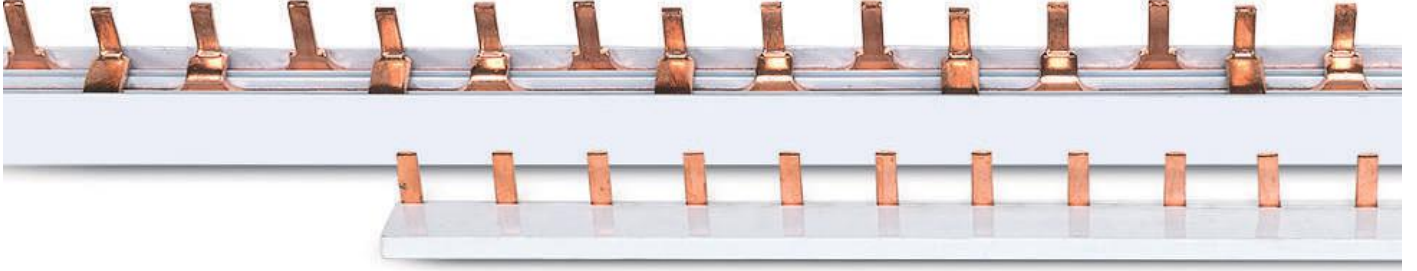

MONOFAZE MÜŞTEREK OTOMAT BARALARI

ÜRÜN KODU	BAKIR KALINLIĞI	BOY	MODÜL	AMPER	AÇIKLAMA	KUTU ADEDİ	FİYAT
PMB-0531	1 mm	53 cm	30	80 A	Monofaze Müşterek W Otomat Bara	25	15.00 TL
PMB-1061	1 mm	106 cm	60	80 A	Monofaze Müşterek W Otomat Bara	25	30.00 TL
PMB-0535	1.5 mm	53 cm	30	100 A	Monofaze Müşterek W Otomat Bara	25	23.00 TL
PMB-1065	1.5 mm	106 cm	60	100 A	Monofaze Müşterek W Otomat Bara	25	46.00 TL



TRİFAZE MÜŞTEREK OTOMAT BARALARI

ÜRÜN KODU	BAKIR KALINLIĞI	BOY	MODÜL	AMPER	AÇIKLAMA	KUTU ADEDİ	FİYAT
PTB-0531	1 mm	53 cm	30	80 A	Trifaze Müşterek W Otomat Bara	25	40.00 TL
PTB-1061	1 mm	106 cm	60	80 A	Trifaze Müşterek W Otomat Bara	25	80.00 TL
PTB-0535	1.5 mm	53 cm	30	100 A	Trifaze Müşterek W Otomat Bara	25	60.00 TL
PTB-1065	1.5 mm	106 cm	60	100 A	Trifaze Müşterek W Otomat Bara	25	120.00 TL
PTB-BK					Trifaze Otomat Barası Yan Koruma Kapağı		0.27 TL

ABS ve POLİKARBONAT PANOLAR



POLİÜRETAN
CONTALI



OPAK KAPAKLI ABS PANOLAR

KOD	ÖLÇÜ (cm)	RENK	KORUMA SINIFI	BAĞ ADEDİ	FİYAT
PP3001	20x30x13	RAL 7035 Gri	IP65	15	96.00 TL
PP3002	25x35x15	RAL 7035 Gri	IP65	15	105.00 TL
PP3004	30x40x17	RAL 7035 Gri	IP65	10	140.00 TL
PP3005	30x40x22	RAL 7035 Gri	IP65	10	177.00 TL
PP3006	35x50x19	RAL 7035 Gri	IP65	5	220.00 TL
PP3003	40x50x17,5	RAL 7035 Gri	IP65	5	224.00 TL
PP3007	40x50x24	RAL 7035 Gri	IP65	5	265.00 TL
PP3008	40x60x20	RAL 7035 Gri	IP65	5	265.00 TL
PP3010	50x70x25	RAL 7035 Gri	IP65	3	450.00 TL
PP3021	60x80x26	RAL 7035 Gri	IP65	3	750.00 TL



POLİÜRETAN
CONTALI



ŞEFFAF KAPAKLI ABS POLİKARBONAT PANOLAR

KOD	ÖLÇÜ (cm)	RENK	KORUMA SINIFI	BAĞ ADEDİ	FİYAT
PP3011	20x30x13	RAL 7035 Gri	IP65	15	121.00 TL
PP3012	25x35x15	RAL 7035 Gri	IP65	15	132.00 TL
PP3014	30x40x17	RAL 7035 Gri	IP65	10	170.00 TL
PP3015	30x40x22	RAL 7035 Gri	IP65	10	205.00 TL
PP3016	35x50x19	RAL 7035 Gri	IP65	5	255.00 TL
PP3013	40x50x17,5	RAL 7035 Gri	IP65	5	280.00 TL
PP3017	40x50x24	RAL 7035 Gri	IP65	5	320.00 TL
PP3018	40x60x20	RAL 7035 Gri	IP65	5	320.00 TL
PP3020	50x70x25	RAL 7035 Gri	IP65	3	600.00 TL
PP3022	60x80x26	RAL 7035 Gri	IP65	3	980.00 TL

ABS ve POLİKARBONAT DAĞITIM PANOLARI



POLİÜRETAN
CONTALI



OPAK KAPAKLI ABS OTOMAT PANOLARI

KOD	ÖLÇÜ (cm)	ÖZELLİK	RENK	KORUMA SINIFI	BAĞ ADEDİ	FİYAT
PP3102	25x35x15	18 OTOMATLI (9x2)	RAL 7035 Gri	IP65	15	162.00 TL
PP3104	30x40x17	24 OTOMATLI (12x2)	RAL 7035 Gri	IP65	10	206.00 TL
PP3106	35x50x19	45 OTOMATLI (15x3)	RAL 7035 Gri	IP65	5	355.00 TL
PP3108	40x60x20	60 OTOMATLI (15x4)	RAL 7035 Gri	IP65	5	363.00 TL



POLİÜRETAN
CONTALI



ŞEFFAF KAPAKLI POLİKARBONAT OTOMAT PANOLARI

KOD	ÖLÇÜ (cm)	ÖZELLİK	RENK	KORUMA SINIFI	BAĞ ADEDİ	FİYAT
PP3112	25x35x15	18 OTOMATLI (9x2)	RAL 7035 Gri	IP65	15	207.00 TL
PP3114	30x40x17	24 OTOMATLI (12x2)	RAL 7035 Gri	IP65	10	242.00 TL
PP3116	35x50x19	45 OTOMATLI (15x3)	RAL 7035 Gri	IP65	5	430.00 TL
PP3118	40x60x20	60 OTOMATLI (15x4)	RAL 7035 Gri	IP65	5	450.00 TL

ABS PANO AKSESUARLARI

GALVANİZ TABAN SAÇLARI



KOD	KALINLIK	PANO ÖLÇÜSÜ	FİYAT
PTS3001	1mm	20x30x13cm	23.00 TL
PTS3002	1mm	25x35x15cm	26.00 TL
PTS3004	1mm	30x40x17cm	29.00 TL
PTS3005	1mm	30x40x22cm	29.00 TL
PTS3006	1mm	35x50x19cm	30.00 TL
PTS3003	1mm	40x50x17,5cm	32.00 TL
PTS3007	1mm	40x50x24cm	32.00 TL
PTS3008	1mm	40x60x20cm	42.00 TL
PTS3010	1mm	50x70x25cm	65.00 TL

MODÜLER KİTLER ve SEPERATÖRLER



KOD	AÇIKLAMA	PANO ÖLÇÜSÜ	FİYAT
PMK3102	Modüler Pano İç Montaj Kiti 18 (9x2) Otomat	25x35x15cm	26.00 TL
PMK3104	Modüler Pano iç Montaj Kiti 24 (12x2) Otomat	30x40x17cm	30.00 TL
PMK3106	Modüler Pano iç Montaj Kiti 45 (15x3) Otomat	35x50x19cm	48.00 TL
PMK3108	Modüler Pano iç Montaj Kiti 60 (15x4) Otomat	40x60x20cm	61.00 TL
PMS3102	PP3102-PP3112 için Plastik Perde	25x35x15cm	19.00 TL
PMS3104	PP3104-PP3114 için Plastik Perde	30x40x17cm	26.00 TL
PMS3106	PP3106-PP3116 için Plastik Perde	35x50x19cm	39.00 TL
PMS3108	PP3108-PP3118 için Plastik Perde	40x60x20cm	42.00 TL

PANO AKSESUARLARI



PPA01

YENİ ÜRÜN



PPA05



PPA03



PPA02



PPA04

KOD	AÇIKLAMA	FİYAT
PPA01	Kilit Göbek Takımı	9.80 TL
PPA02	Pano Duvara Tuturma Aparatı (4'lü Set)	13.00 TL
PPA03	Plastik Üçgen Anahtar	5.20 TL
PPA04	Pano Separatörü Tuturma Vidası	5.20 TL
PPA05	Plastik Kilitlenebilir Pano Kilidi	36.00 TL

PANO TİPİ DELİKLİ KABLO KANALLARI

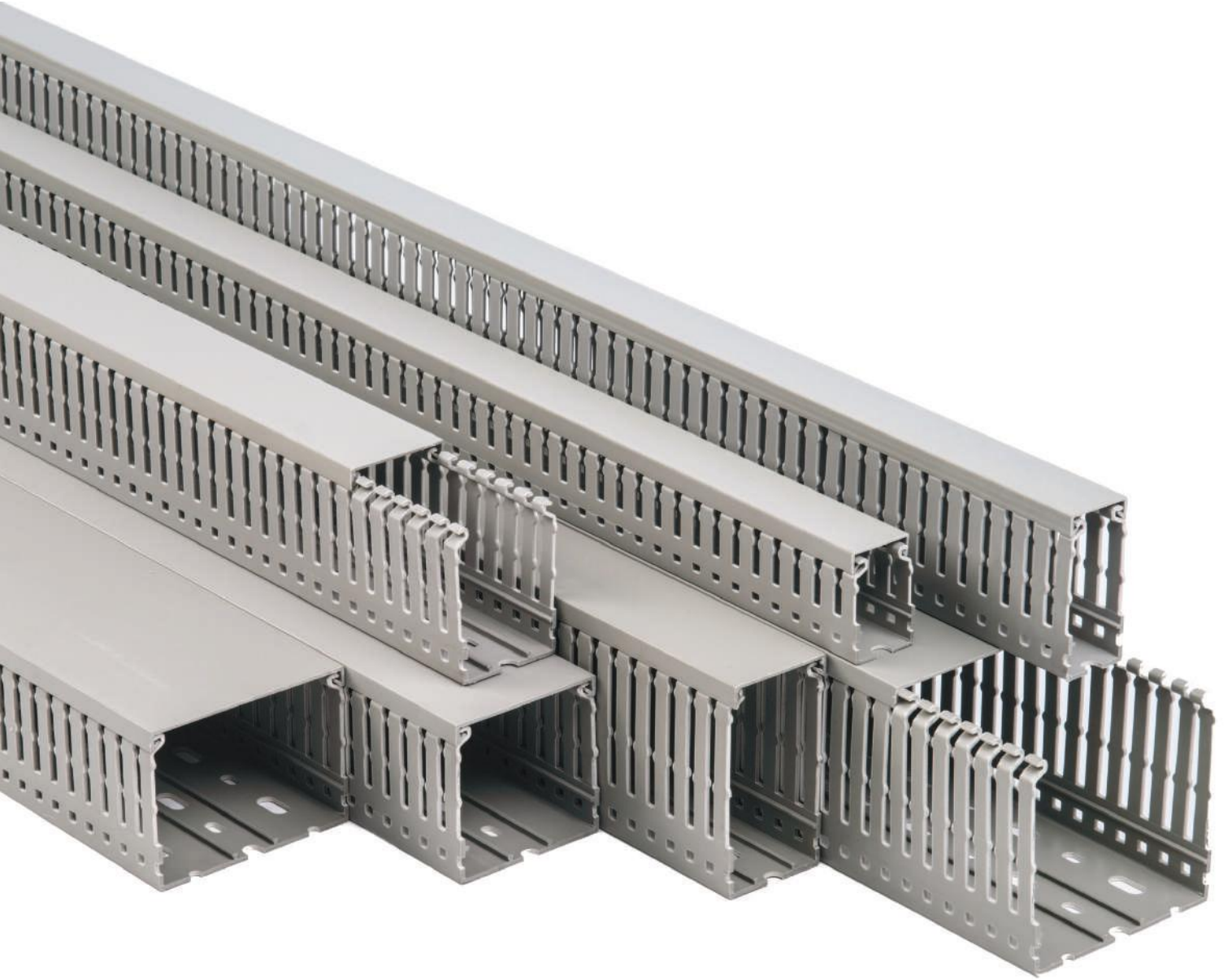

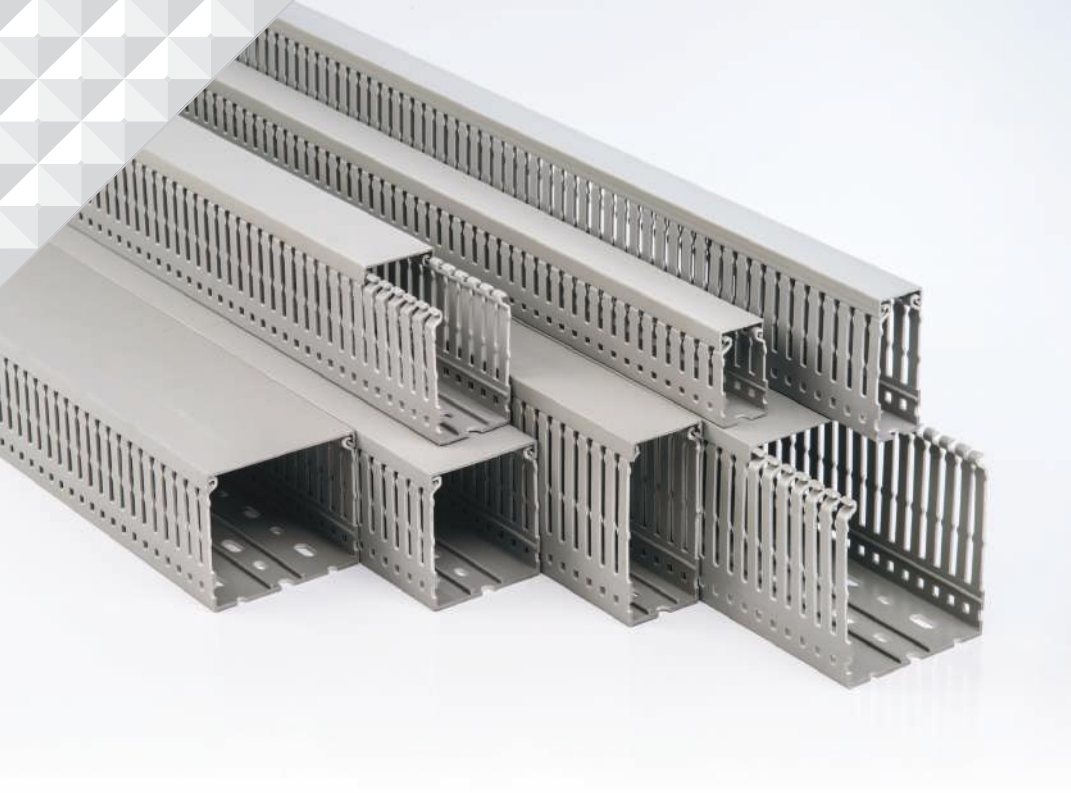

PANO TİPİ DELİKLİ KABLO KANALLARI

- UL94-VO Alev İletmez
- EN-50085 2-3
- Renk RAL 7030 Gri
- CE
- RoHS



DELİKLİ KABLO KANALLARI

KOD	ÖLÇÜ (mm)	SLOT ARALIĞI (mm)	RENK	AMBALAJ / ADET	FİYAT
PDK 2530	25x30	4/6/4 mm	RAL 7030 Gri	60x2m	12.20 TL
PDK 2540	25x40	4/6/4 mm	RAL 7030 Gri	64x2m	12.50 TL
PDK 2560	25x60	4/6/4 mm	RAL 7030 Gri	48x2m	21.00 TL
PDK 2580	25x80	4/6/4 mm	RAL 7030 Gri	32x2m	26.00 TL
PDK 4040	40x40	4/6/4 mm	RAL 7030 Gri	35x2m	18.00 TL
PDK 4060	40x60	4/6/4 mm	RAL 7030 Gri	30x2m	24.00 TL
PDK 4080	40x80	4/6/4 mm	RAL 7030 Gri	20x2m	34.00 TL
PDK 4010	40x100	5/8/5 mm	RAL 7030 Gri	20x2m	41.00 TL
PDK 6040	60x40	4/6/4 mm	RAL 7030 Gri	25x2m	26.00 TL
PDK 6060	60x60	4/6/4 mm	RAL 7030 Gri	24x2m	31.00 TL
PDK 6080	60x80	4/6/4 mm	RAL 7030 Gri	16x2m	41.00 TL
PDK 6010	60x100	5/8/5 mm	RAL 7030 Gri	16x2m	48.00 TL
PDK 8060	80x60	4/6/4 mm	RAL 7030 Gri	14x2m	39.00 TL
PDK 8080	80x80	4/6/4 mm	RAL 7030 Gri	12x2m	48.00 TL
PDK 8010	80x100	5/8/5 mm	RAL 7030 Gri	12x2m	68.00 TL
PDK 1060	100x60	4/6/4 mm	RAL 7030 Gri	10x2m	50.00 TL
PDK 1080	100x80	4/6/4 mm	RAL 7030 Gri	10x2m	60.00 TL
PDK 1010	100x100	5/8/5 mm	RAL 7030 Gri	8x2m	95.00 TL
PDK 1260	120x60	4/6/4 mm	RAL 7030 Gri	10x2m	62.00 TL
PDK 1280	120x80	4/6/4 mm	RAL 7030 Gri	8x2m	83.00 TL

DELİKLİ KANAL AKSESUARLARI

DELİKLİ KANAL KAPAKLARI



KOD	ÖLÇÜ (mm)	RENK	AMBALAJ / ADET	FİYAT
PDC 25	25	RAL 7030 Gri	50 Adet	6.00 TL
PDC 40	40	RAL 7030 Gri	50 Adet	10.00 TL
PDC 60	60	RAL 7030 Gri	50 Adet	16.00 TL
PDC 80	80	RAL 7030 Gri	50 Adet	25.00 TL
PDC 100	100	RAL 7030 Gri	50 Adet	36.00 TL
PDC 120	120	RAL 7030 Gri	50 Adet	41.00 TL

KANAL KESME MAKASI

KOD	MAX. KESİM ÖLÇÜSÜ	AMBALAJ / ADET	FİYAT
PDC 110	60mm	1 Adet	2.925.00 TL
PDC 250	150mm	1 Adet	6.825.00 TL



PDC 110



PDC 250

PANO İKLİMLENDİRME ÜRÜNLERİ



YENİ

KABLO BAĞLARI



plastim[®]

TEPE FANI



Standart

Hızlı Bağlantı (G)

KOD	FAN TİPİ	BESLEME	GÜÇ	NOMİNAL AKIM	GÜRÜLTÜ SEVİYESİ	KAPASİTE	FİYAT
PFF 4000	Ø172x163x51 AKSİYEL	220v AC 50/60hz	25/32W	0,11/0,15A	57dB	400m ³ /h	100.00 \$
PFF 5500	Ø190x68 RADYAL	220v AC 50/60hz	58/75W	0,26/0,34A	62dB	560m ³ /h	140.00 \$
PFF 6000	Ø220x71 RADYAL	220v AC 50/60hz	85/90W	0,38/0,44A	73dB	970m ³ /h	150.00 \$
PFF 5500-110	Ø190x68 RADYAL	110v AC 50/60hz	60/73W	0,54/0,64A	63dB	560m ³ /h	160.00 \$
PFF 6000-110	Ø220x71 RADYAL	110v AC 50/60hz	83/93W	0,79/0,81A	70dB	970m ³ /h	170.00 \$
PFF 4000-G	Ø172x163x51 AKSİYEL	220v AC 50/60hz	25/32W	0,11/0,15A	57dB	400m ³ /h	100.00 \$
PFF 5500-G	Ø190x68 RADYAL	220v AC 50/60hz	58/75W	0,26/0,34A	62dB	560m ³ /h	140.00 \$
PFF 6000-G	Ø220x71 RADYAL	220v AC 50/60hz	85/90W	0,38/0,44A	73dB	970m ³ /h	150.00 \$



IP54



Poliüretan Conta



Radyal Fan

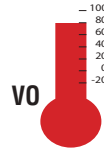

VO Alev İletmez ABS

TEKNİK RESİM

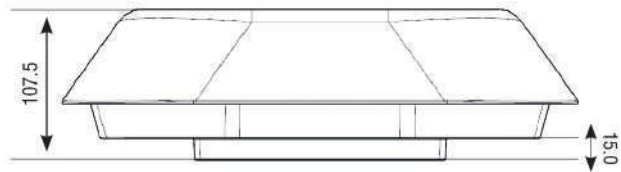
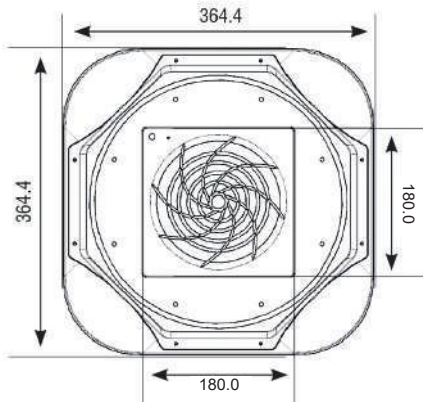

TEPE FANI DESIGN SERİSİ



Vidasız hızlı ve kolay montaj !



KOD	FAN TİPİ	BESLEME	GÜÇ	NOMİNAL AKIM	GÜRÜLTÜ SEVİYESİ	KAPASİTE	FİYAT
PTS 4000	Ø172x163x51 AKSİYEL	220v AC 50/60hz	25/32W	0,11/0,15A	57dB	400m ³ /h	100.00 \$
PTS 5500	Ø190x68 RADYAL	220v AC 50/60hz	58/75W	0,26/0,34A	62dB	560m ³ /h	140.00 \$
PTS 6000	Ø220x71 RADYAL	220v AC 50/60hz	85/90W	0,38/0,44A	73dB	970m ³ /h	150.00 \$
PTS 5500-110	Ø190x68 RADYAL	110v AC 50/60hz	60/73W	0,54/0,64A	63dB	560m ³ /h	160.00 \$
PTS 6000-110	Ø220x71 RADYAL	110v AC 50/60hz	83/93W	0,79/0,64A	70dB	970m ³ /h	170.00 \$



IP54



Poliüretan Conta



Radyal Fan



VO Alev İletmez ABS



Hızlı ve Kolay Montaj

TEKNİK RESİM

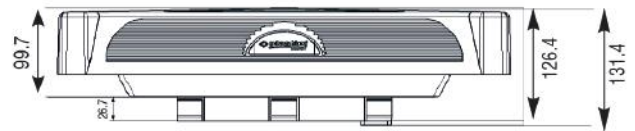
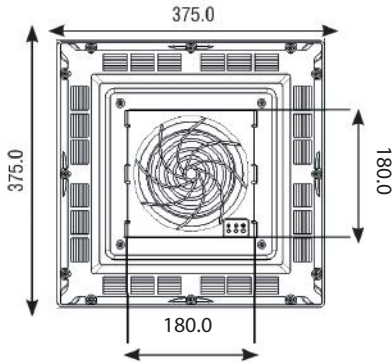

PANO İÇİ TERMOSTAT ve HİGROSTAT

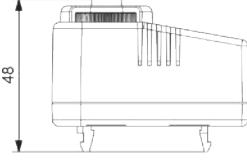
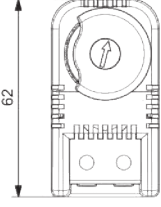
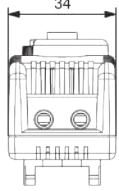
Ağırlık: 45 gr
Koruma Sınıfı: IP20

AÇIKLAMA	AYAR SAHASI	KONTAK TİPİ	KORUMA SINIFI	KOD	KOLİ ADEDİ
ISITMA TERMOSTATI	0-60C	NK	IP20	PTHT	135

PTHT - TERMOSTAT - NK **FİYAT: 9.00 \$**

Ağırlık: 45 gr
Koruma Sınıfı: IP20

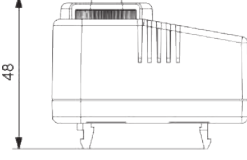
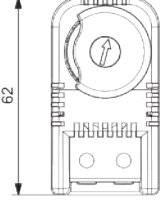
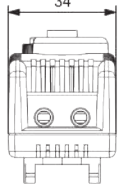
AÇIKLAMA	AYAR SAHASI	KONTAK TİPİ	KORUMA SINIFI	KOD	KOLİ ADEDİ
SOĞUTMA TERMOSTATI	0-60C	NA	IP20	PTVT	135

PTVT - TERMOSTAT - NA **FİYAT: 9.00 \$**

Ağırlık: 80 gr
Koruma Sınıfı: IP20

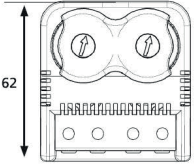
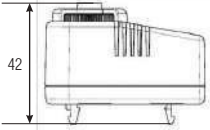
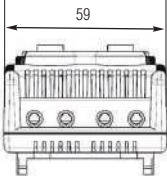
AÇIKLAMA	AYAR SAHASI	KONTAK TİPİ	KORUMA SINIFI	KOD	KOLİ ADEDİ
DUAL TERMOSTAT	0-60C / 0-60C	NK+NA	IP20	PTHVT	60

PTHVT - TERMOSTAT - NK+NA **FİYAT: 20.00 \$**

Ağırlık: 180gr
Koruma Sınıfı: IP20

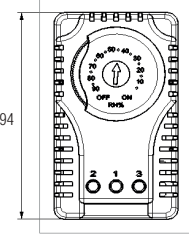
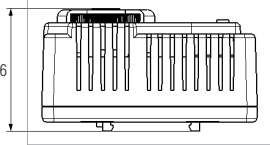
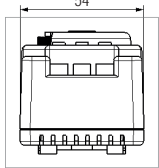
AÇIKLAMA	AYAR SAHASI	KONTAK TİPİ	KORUMA SINIFI	KOD	KOLİ ADEDİ
MEKANİK HİGROSTAT	%10-90RH	1CO	IP20	PHG02	30

PHG02 - HİGROSTAT **FİYAT: 50.00 \$**

DİJİTAL TERMOSTAT ve HİGROSTAT

PDT 50-150 SICAKLIK KONTROL CİHAZI

FİYAT: 60.00 \$

TEKNİK ÖZELLİKLER

Ebatlar	: 36x90x65mm raya montaj
Gösterge	: 3 Hane 7 Segment
Sensör	: PTC
Ölçme Sıkalası	: -50...+150 °C
Duyarlılık	: \pm °C
Doğruluk	: \pm %1 (Tam Skalanın)
Kontrol Durumu	: ON-OFF
Out Çıkışı	: Röle, 250VAC, 2A, Rezistif Yük
Alarm Çıkışı	: Röle, 250VAC, 2A, Rezistif Yük
Heat set Ayarı	: LoL...UPL °C (Hst)
Alarm Set Ayarı	: AtP=Abs,-Ab; LoL... °C (Ast) AtP=rEL, -rL; (HSt+rAL), (HSt-20) ... (Hst+20) °C
Heat Histeresiz	: 1...20 °C (Hhs)
Alarm Histeresiz	: 1...20 °C (Hhs)
Offset	: -20...+20 °C (OFS)
Isıtma/Soğutma	:H-C; Ht(Isıtma), CL (soğutma); seçmeli
Besleme Voltajı	:100...240VAC, 50/60 Hz
Güç Tüketimi	:<6VA
Çalışma Sıcaklığı	: -20 °C...55 °C
İşletme İrtifası	:<2000m



NOT : PTC Sensör cihaz dahilindedir.

HT-310 SICAKLIK VE NEM KONTROL CİHAZI

FİYAT: 80.00 \$

TEKNİK ÖZELLİKLER

Ebatlar	: 35x77mm
Gösterge	: 3 Hane 7 Segment
Sensör	: Dijital Sıcaklık Nem Sensörü
Ölçme Sıkalası	: -19,9...+80,0 °C, 5 .. 95%RH
Duyarlılık	: \pm 0,1 °C, \pm 1%RH
Doğruluk	: \pm %1 (°C), \pm %3 (%RH); tam skalanın
Kontrol Durumu	: ON-OFF
°C Out Çıkışı	: Röle (NA+ NK), 250VAC, 2A, Rezistif yük
%RH Out Çıkışı	: Röle, (NA),250VAC, 2A, Rezistif Yük
Isıtma/Soğutma	: Ht (ısıtma), CL(soğutma); seçilebilir
Nem Fonksiyonu	: lo (nem alma), hi (nem verme); seçilebilir
Besleme Voltajı	: 100...220VAC, 50 / 60Hz
Güç Tüketimi	: <6VA
Çalışma Sıcaklığı	: 0...50 °C
İşletme İrtifası	:<2000m



NOT : Sıcaklık ve nem sensörü cihaz dahilindedir.

TERMoeLEKTRİK SOĞUTUCULAR

KOD	SOĞUTMA GÜCÜ	BESLEME	ÖLÇÜLER (mm) (En x Boy x Derinlik)	KESİM ÖLÇÜSÜ (mm)	AĞIRLIK (kg)	FİYAT
PTE 040-24	40W	24V DC	130x120x120	85x85	1.20	205.00 €
PTE 070-24	70W	24V DC	230x125x145	185x105	2.52	250.00 €
PTE 100-24	100W	24V DC	300x150x150	235x130	4.12	370.00 €
PTE 150-24	150W	24V DC	400x180x185	360x225	7.70	445.00 €
PTE 200-24	200W	24V DC	400x180x185	360x225	7.70	500.00 €



Uygulama alanları;

- Elektrik Panoları
- Rack Kabinleri
- Gıda ve İçecek Otomatları
- ATM Makineleri
- Baz İstasyonlar
- Standart Pano Klimalarının maliyet olarak yüksek kaldığı her türlü küçük makine ve tesis uygulamalarında
- Kompresör ve gaz içermediği için bakım gerektirmez.

PANO KLİMALARI



STANDART



INOX PASLANMAZ



IP65 HARİCİ TİP

AÇIKLAMA	SOĞUTMA GÜCÜ	BESLEME	RENK	KOD	FİYAT
STANDART PANO KLİMASI	400 W	230V 50/60 Hz	RAL 7035	PAC 040.01	920.00€
STANDART PANO KLİMASI	500 W	230V 50/60 Hz	RAL 7035	PAC 050.01	1.050.00€
STANDART PANO KLİMASI	750 W	230V 50/60 Hz	RAL 7035	PAC 075.01	1.200.00€
STANDART PANO KLİMASI	1000 W	230V 50/60 Hz	RAL 7035	PAC 100.01	1.400.00€
STANDART PANO KLİMASI	1500 W	230V 50/60 Hz	RAL 7035	PAC 150.01	1.580.00€
STANDART PANO KLİMASI	2000 W	230V 50/60 Hz	RAL 7035	PAC 200.01	2.050.00€
STANDART PANO KLİMASI	2500 W	230V 50/60 Hz	RAL 7035	PAC 250.01	2.450.00€
STANDART PANO KLİMASI	3500 W	230V 50/60 Hz	RAL 7035	PAC 350.01	3.500.00€





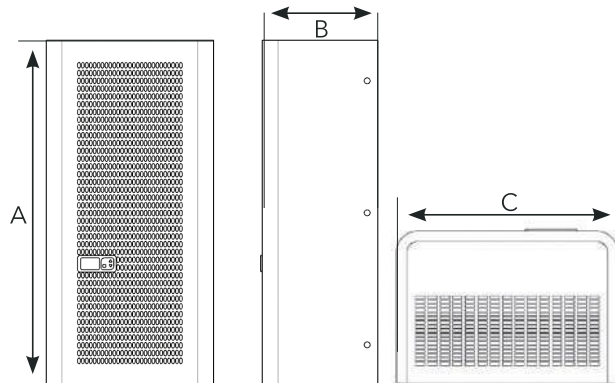

INOX PANO KLİMASI	400 W	230V 50/60 Hz	INOX	PAC 040.02	1.100.00€
INOX PANO KLİMASI	500 W	230V 50/60 Hz	INOX	PAC 050.02	1.250.00€
INOX PANO KLİMASI	750 W	230V 50/60 Hz	INOX	PAC 075.02	1.400.00€
INOX PANO KLİMASI	1000 W	230V 50/60 Hz	INOX	PAC 100.02	1.600.00€
INOX PANO KLİMASI	1500 W	230V 50/60 Hz	INOX	PAC 150.02	1.780.00€
INOX PANO KLİMASI	2000 W	230V 50/60 Hz	INOX	PAC 200.02	2.250.00€
INOX PANO KLİMASI	2500 W	230V 50/60 Hz	INOX	PAC 250.02	2.650.00€
INOX PANO KLİMASI	3500 W	230V 50/60 Hz	INOX	PAC 350.02	3.800.00€

IP65 PANO KLİMASI	400 W	230V 50/60 Hz	RAL 7035	PAC 040.03	1.100.00€
IP65 PANO KLİMASI	500 W	230V 50/60 Hz	RAL 7035	PAC 050.03	1.250.00€
IP65 PANO KLİMASI	750 W	230V 50/60 Hz	RAL 7035	PAC 075.03	1.400.00€
IP65 PANO KLİMASI	1000 W	230V 50/60 Hz	RAL 7035	PAC 100.03	1.600.00€
IP65 PANO KLİMASI	1500 W	230V 50/60 Hz	RAL 7035	PAC 150.03	1.780.00€
IP65 PANO KLİMASI	2000 W	230V 50/60 Hz	RAL 7035	PAC 200.03	2.250.00€
IP65 PANO KLİMASI	2500 W	230V 50/60 Hz	RAL 7035	PAC 250.03	2.650.00€
IP65 PANO KLİMASI	3500 W	230V 50/60 Hz	RAL 7035	PAC 350.03	3.800.00€



KOD	A(mm)	B(mm)	C(mm)	AĞIRLIK(kg)
PAC040	500	200	240	14.00
PAC050	500	205	310	18.00
PAC075	610	210	320	26.30
PAC100	640	210	320	28.50
PAC150	800	255	400	32.00
PAC200	1000	255	400	43.50
PAC250	1000	255	400	44.00
PAC350	1200	255	400	46.00



DAĞITICI ÜNİTELER

	Sipariş Kodu PDB 207	Kablo Cinsi	Kablo Kesiti mm²		FİYAT TL/adet
	Kutup Sayısı 2			Giriş	
	Akım 125 Amper	Tek Damar	1x10-35 mm ²	1x10-25 mm ² 5x2,5-6 mm ²	28.00 TL
	Sipariş Kodu PDB 211	Kablo Cinsi	Kablo Kesiti mm²		FİYAT TL/adet
	Kutup Sayısı 2			Giriş	
	Akım 125 Amper	Tek Damar	2x10-35 mm ²	2x10-25 mm ² 7x2,5-6 mm ²	38.00 TL
	Sipariş Kodu PDB 215	Kablo Cinsi	Kablo Kesiti mm²		FİYAT TL/adet
	Kutup Sayısı 2			Giriş	
	Akım 125 Amper	Tek Damar	2x10-35 mm ²	2x10-25 mm ² 11x2,5-6 mm ²	52.00 TL
	Sipariş Kodu PDB 407	Kablo Cinsi	Kablo Kesiti mm²		FİYAT TL/adet
	Kutup Sayısı 4			Giriş	
	Akım 125 Amper	Tek Damar	1x10-35 mm ²	1x10-25 mm ² 5x2,5-6 mm ²	52.00 TL
	Sipariş Kodu PDB 411	Kablo Cinsi	Kablo Kesiti mm²		FİYAT TL/adet
	Kutup Sayısı 4			Giriş	
	Akım 125 Amper	Tek Damar	2x10-35 mm ²	2x10-25 mm ² 7x2,5-6 mm ²	72.00 TL
	Sipariş Kodu PDB 415	Kablo Cinsi	Kablo Kesiti mm²		FİYAT TL/adet
	Kutup Sayısı 4			Giriş	
	Akım 125 Amper	Tek Damar	2x10-35 mm ²	2x10-25 mm ² 11x2,5-6 mm ²	90.00 TL
	Sipariş Kodu PDB 4160	Kablo Cinsi	Kablo Kesiti mm²		FİYAT TL/adet
	Kutup Sayısı 4				
	Akım 160 Amper				170.00 TL

DAĞITICI ÜNİTELER

	Sipariş Kodu PDB 80	Kablo Kesiti mm²		FİYAT TL/adet
		Giriş	Çıkış	
	Akım 80 Amper	1x6-16 mm ²	4x2,5-6 mm ² 2x2,5-16 mm ²	24.00 TL
	Sipariş Kodu PDB 125	Kablo Kesiti mm²		FİYAT TL/adet
		Giriş	Çıkış	
	Akım 125 Amper	1x10-35 mm ²	6x2,5-16 mm ² Köprü 1x6-16 mm ²	50.00 TL
	Sipariş Kodu PDB 160	Kablo Kesiti mm²		FİYAT TL/adet
		Giriş	Çıkış	
	Akım 160 Amper	1x10-70 mm ²	6x2,5-16 mm ² Köprü 1x6-16 mm ²	53.00 TL
	Sipariş Kodu PDB 250	Kablo Kesiti mm²		FİYAT TL/adet
		Giriş	Çıkış	
	Akım 250 Amper	1x35-120 mm ²	4x2,5-10 mm ² 5x2,5-16 mm ² 2x6-35 mm ²	145.00 TL
	Sipariş Kodu PDB 400	Kablo Kesiti mm²		FİYAT TL/adet
		Giriş	Çıkış	
	Akım 400 Amper	1x95-185 mm ²	4x2,5-10 mm ² 5x2,5-16 mm ² 2x6-35 mm ²	150.00 TL
	Sipariş Kodu PDB 500	Kablo Kesiti mm²		FİYAT TL/adet
		Giriş	Çıkış	
	Akım 500 Amper	Bara 8x24 mm ²	4x2,5-10 mm ² 5x2,5-16 mm ² 2x6-35 mm ²	160.00 TL
	Sipariş Kodu PDB 4200	Dört Kutuplu 200 Amper		FİYAT TL/adet
	Kutup Sayısı 4			
	Akım 200 Amper			240.00 TL

PANO ISITICILARI



MPHT MİNİ ISITICI



PHT PTC ISITICI



PSHT SLIM PTC ISITICI



AÇIKLAMA	BESLEME	KORUMA SINIFI	BAĞLANTI	KOD	FİYAT
15 W PTC PANO ISITICISI	100-250V AC-DC	IP20	KABLO	MPHT 15	22.00 \$
25 W PTC PANO ISITICISI	100-250V AC-DC	IP20	KABLO	MPHT 25	25.00 \$
30 W PTC PANO ISITICISI	100-250V AC-DC	IP20	KLEMENS	PHT 030	32.00 \$
50 W PTC PANO ISITICISI	100-250V AC-DC	IP20	KLEMENS	PHT 050	36.00 \$
75 W PTC PANO ISITICISI	100-250V AC-DC	IP20	KLEMENS	PHT 075	37.00 \$
100 W PTC PANO ISITICISI	100-250V AC-DC	IP20	KLEMENS	PHT 100	50.00 \$
150 W PTC PANO ISITICISI	100-250V AC-DC	IP20	KLEMENS	PHT 150	68.00 \$
30 W SLIM PTC PANO ISITICISI	100-250V AC-DC	IP20	KLEMENS	PSHT 030	30.00 \$
50 W SLIM PTC PANO ISITICISI	100-250V AC-DC	IP20	KLEMENS	PSHT 050	32.00 \$
75 W SLIM PTC PANO ISITICISI	100-250V AC-DC	IP20	KLEMENS	PSHT 075	33.00 \$
100 W SLIM PTC PANO ISITICISI	100-250V AC-DC	IP20	KLEMENS	PSHT 100	46.00 \$
150 W SLIM PTC PANO ISITICISI	100-250V AC-DC	IP20	KLEMENS	PSHT 150	64.00 \$

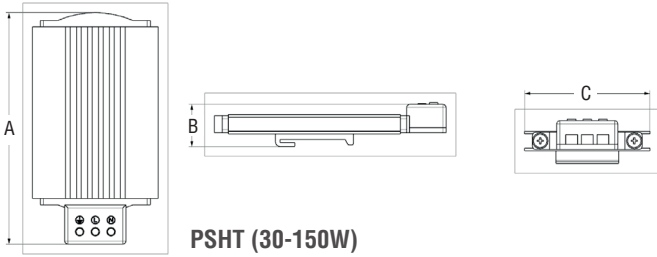

PSHT (30-150W)

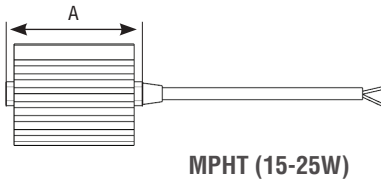

MPHT (15-25W)

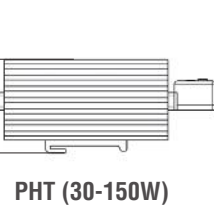
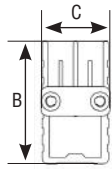

PHT (30-150W)

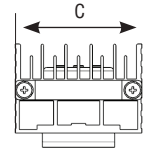

KOD	A (mm)	B (mm)	C (mm)	Ağırlık (gr)	KOD	A (mm)	B (mm)	C (mm)	Ağırlık (gr)
MPHT 15	60	50	27	110	PHT 150	228	70	59	640
MPHT 25	70	50	27	120	PSHT 030	128	27	80	190
PHT 030	128	70	59	340	PSHT 050	138	27	80	190
PHT 050	138	70	59	360	PSHT 075	178	27	80	225
PHT 075	178	70	59	500	PSHT 100	188	27	80	235
PHT 100	188	70	59	520	PSHT 150	228	27	80	325

FANLI PANO ISITICILARI



PFHT FANLI PTC ISITICI



PFHT FANLI ISITICI



PFHT 400W PLASTİK FANLI ISITICI



AÇIKLAMA	BESLEME	KORUMA SINIFI	BAĞLANTI	KOD	FİYAT
100 W FANLI PTC PANO ISITICISI	230V AC 50/60 Hz	IP20	KLEMENS	PFHT 100	94.00 \$
150 W FANLI PTC PANO ISITICISI	230V AC 50/60 Hz	IP20	KLEMENS	PFHT 150	105.00 \$
250 W FANLI REZİSTANS PANO ISITICISI	230V AC 50/60 Hz	IP20	KLEMENS	PFHT 250	118.00 \$
500 W FANLI REZİSTANS PANO ISITICISI	230V AC 50/60 Hz	IP20	KLEMENS	PFHT 500	138.00 \$
750 W FANLI REZİSTANS PANO ISITICISI	230V AC 50/60 Hz	IP20	KLEMENS	PFHT 750	165.00 \$
200/300/400 W FANLI PTC PANO ISITICISI	230V AC 50/60 Hz	IP20	KABLO	PFHT 400	130.00 \$

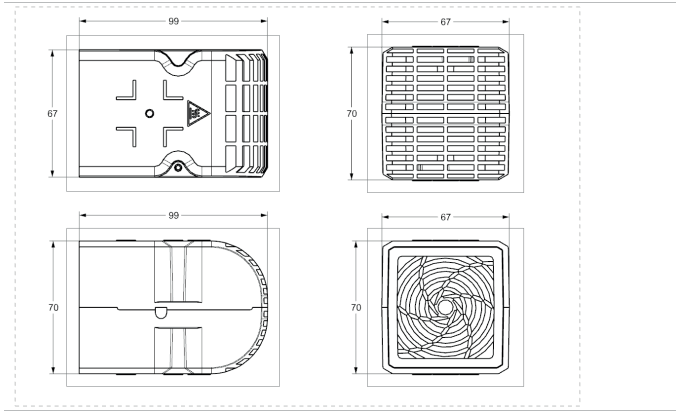

PFHT 400W

PFHT400 Fanlı Isıtıcı Özellikleri

- Bağlantı şekline göre 200w / 300w / 400w çalışabilme
- PPS + Cam Elyaf özel plastik gövde (280°C sıcaklığa dayanma)
- Plastik gövde sayesinde touchproof özelliği

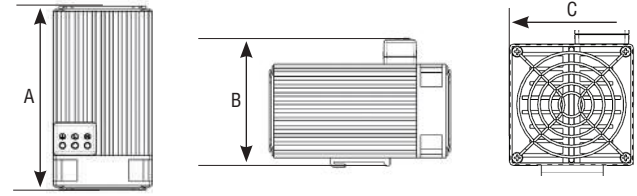
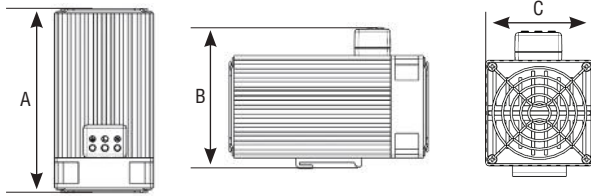

KOD	A (mm)	B (mm)	C (mm)	Ağırlık (gr)
PFHT 100	170	89	60	700
PFHT 150	210	89	60	940
PFHT 250	152	110	80	1040
PFHT 500	182	110	80	1260
PFHT 750	232	110	80	1540
PFHT 400	99	70	67	250

SIKMALI KABLO PABUÇLARI



 **plastim**®

SKP SIKMALI KABLO PABUÇLARI



ÜRÜN KODU	KABLO KESİTİ	CİVATA ÖLÇÜSÜ	D4	ET KALINLIĞI	A	D1	B	C1	C2	L	AMBALAJ MİKTARI	FİYAT
SKP10-5	10 mm	M5	6,2	0,75	13,3	4,7	10,5	7,2	8,8	29,8	800	0.98 TL
SKP16-6	16 mm	M6	7,9	0,75	18,5	6,4	11,8	7,1	7,5	33,5	500	1.14 TL
SKP25-8	25 mm	M8	9,0	0,85	22,1	7,3	13,2	7,8	9,0	38,6	300	1.63 TL
SKP35-8	35 mm	M8	10,8	1,15	25,5	8,5	15,5	9,3	9,6	44,5	200	2.85 TL
SKP35-10	35 mm	M10	10,8	1,15	25,5	8,5	15,5	9,3	9,6	44,5	200	2.85 TL
SKP50-10	50 mm	M10	12,6	1,30	28,6	10,0	18,2	10,8	12,1	51,5	150	4.06 TL
SKP70-10	70 mm	M10	14,5	1,50	34,5	11,5	21,0	10,8	10,0	55,0	100	5.85 TL
SKP95-10	95 mm	M10	16,5	1,50	37,0	13,5	24,2	10,85	12,0	60,0	80	8.05 TL
SKP95-12	95 mm	M12	16,5	1,50	37,0	13,5	24,2	10,85	12,0	60,0	80	8.05 TL
SKP120-12	120 mm	M12	19,1	1,80	43,0	15,5	28,0	13,9	13,2	70,0	50	10.90 TL
SKP150-12	150 mm	M12	20,6	1,80	43,2	17,0	30,2	16,3	16,0	75,5	30	12.20 TL
SKP185-16	185 mm	M16	22,6	1,90	47,3	18,8	33,5	17,0	18,6	83,0	30	14.30 TL
SKP240-16	240 mm	M16	25,2	2,00	54,7	21,2	37,5	17,35	18,2	90,0	25	21.80 TL

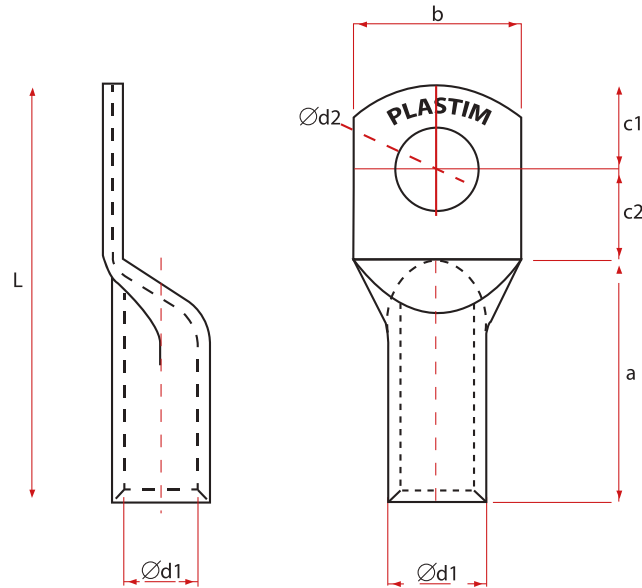

DIN RAYLARI VE RAY TAŞIYICI

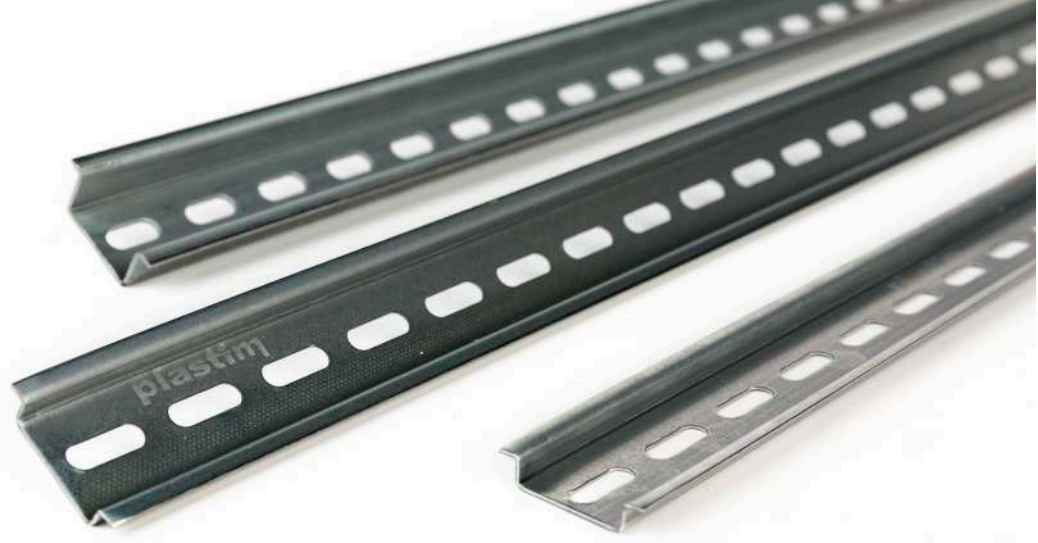

KOD	ÖLÇÜ	TİP	UZUNLUK	AMBALAJ ADET	FİYAT
PDR1001	35x7.5mm	DÜZ	1mt	20	9.80 TL
PDR1002	35x7.5mm	DÜZ	2mt	20	19.50 TL
PDR2001	35x7.5mm	DELİKLİ	1mt	20	9.80 TL
PDR2002	35x7.5mm	DELİKLİ	2mt	20	19.50 TL

KOD	ÖLÇÜ	TİP	UZUNLUK	AMBALAJ ADET	FİYAT
PDR3001	35x15mm	DÜZ	1mt	10	24.50 TL
PDR3002	35x15mm	DÜZ	2mt	10	40.50 TL
PDR4001	35x15mm	DELİKLİ	1mt	10	24.50 TL
PDR4002	35x15mm	DELİKLİ	2mt	10	40.50 TL



PRT

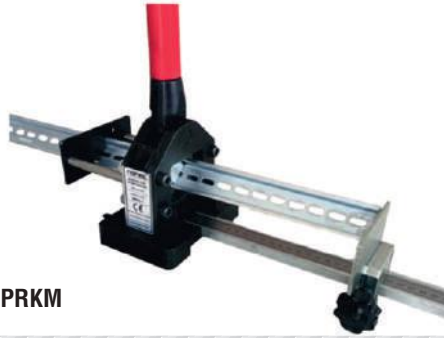

PRKM

KOD	AÇIKLAMA	AMBALAJ / ADET	FİYAT
PRT	Ray Taşıyıcı	25 Adet	4.00 TL
PRKM	Ray Kesme Makası - 35x7.5-35x15mm	1 Adet	5.200 TL

PET KABLO ÇORAPLARI

- Halogen free
- VW-1 Alev iletmez
- -60...+150C
- RoHS





KOD	AÇIKLAMA	RULO METRAJİ	FİYAT
PKC-03	PET Kablo Çorabı 3 mm Siyah	100m	0.22 \$
PKC-06	PET Kablo Çorabı 6 mm Siyah	100m	0.26 \$
PKC-08	PET Kablo Çorabı 8 mm Siyah	100m	0.36 \$
PKC-10	PET Kablo Çorabı 10 mm Siyah	100m	0.40 \$
PKC-12	PET Kablo Çorabı 12 mm Siyah	100m	0.50 \$
PKC-15	PET Kablo Çorabı 15 mm Siyah	100m	0.54 \$
PKC-20	PET Kablo Çorabı 20 mm Siyah	50m	0.72 \$
PKC-25	PET Kablo Çorabı 25 mm Siyah	50m	0.90 \$
PKC-30	PET Kablo Çorabı 30 mm Siyah	50m	1.20 \$
PKC-40	PET Kablo Çorabı 40 mm Siyah	50m	1.60 \$
PKC-50	PET Kablo Çorabı 50 mm Siyah	25m	2.10 \$

FİLTRELİ FANLAR



 **plastim**[®]

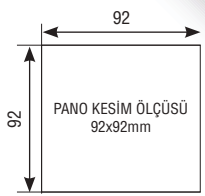
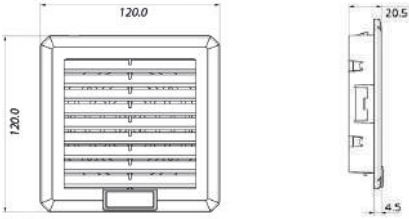

PFI SERİSİ KOLAY MONTAJLI FİLTRELER



KOD	ÖLÇÜLER (mm)	RENK	KORUMA SINIFI	KOLİ ADEDİ
PFI 1000	120x120x20.5	RAL 7035 Gri	IP54	200

PFI 1000 - 120x120mm - IP54

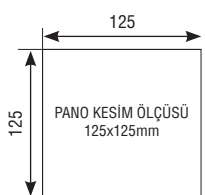
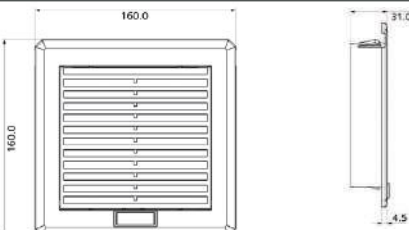

FİYAT: 3.25 \$



KOD	ÖLÇÜLER (mm)	RENK	KORUMA SINIFI	KOLİ ADEDİ
PFI 1500	160x160x31	RAL 7035 Gri	IP54	100

PFI 1500 - 160x160mm - IP54

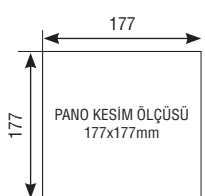
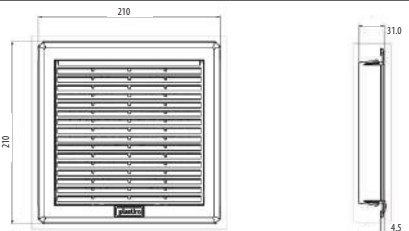

FİYAT: 4.50 \$



KOD	ÖLÇÜLER (mm)	RENK	KORUMA SINIFI	KOLİ ADEDİ
PFI 2000	210x210x31	RAL 7035 Gri	IP54	100

PFI 2000 - 210x210mm - IP54

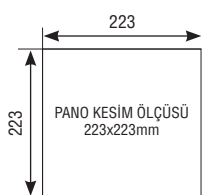
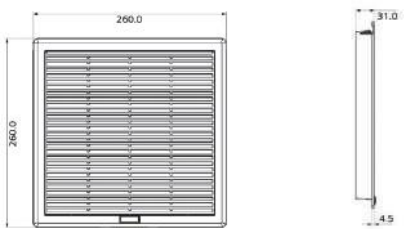

FİYAT: 7.00 \$



KOD	ÖLÇÜLER (mm)	RENK	KORUMA SINIFI	KOLİ ADEDİ
PFI 2500	260x260x31	RAL 7035 Gri	IP54	50

PFI 2500 - 260x260mm - IP54

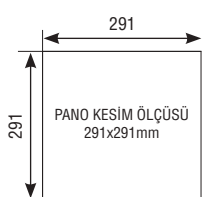
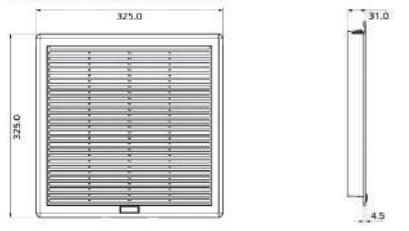
FİYAT: 8.25 \$



KOD	ÖLÇÜLER (mm)	RENK	KORUMA SINIFI	KOLİ ADEDİ
PFI 3000	325x325x31	RAL 7035 Gri	IP54	30

PFI 3000 - 325x325mm - IP54

FİYAT: 15.50 \$



KLEMENS BAĞLANTILI FİLTRELİ FANLAR



PTF SERİSİ KOLAY MONTAJLI

plastim® FİLTRELİ FANLAR

plastim® FANLI

KOD	ÖLÇÜLER (mm)	FAN TİPİ	BESLEME (VAC)	GÜÇ (W)	HIZ (rpm)	FİLTRELİ (m ³ /h)	FİLTRESİZ (m ³ /h)	NOMİNAL AKIM (A)	GÜRÜLTÜ SEVİYESİ (db)
PTF 1000	120x120x58.5	80x80x38 mm	230V-50/60Hz	14 (13)	2800	30	41	0.08 / 0.07	28 (31)

PTF 1000 - 30 m³/h - IP54 **FİYAT: 18.00 \$**

plastim® FANLI

KOD	ÖLÇÜLER (mm)	FAN TİPİ	BESLEME (VAC)	GÜÇ (W)	HIZ (rpm)	FİLTRELİ (m ³ /h)	FİLTRESİZ (m ³ /h)	NOMİNAL AKIM (A)	GÜRÜLTÜ SEVİYESİ (db)
PTF 1500	160x160x69	120x120x38 mm	230V-50/60Hz	26 (23)	2700	100	140	0.14 / 0.13	42 (46)

PTF 1500 - 100 m³/h - IP54 **FİYAT: 25.00 \$**

plastim® FANLI

(Klemens Bağlantılı)

KOD	ÖLÇÜLER (mm)	FAN TİPİ	BESLEME (VAC)	GÜÇ (W)	HIZ (rpm)	FİLTRELİ (m ³ /h)	FİLTRESİZ (m ³ /h)	NOMİNAL AKIM (A)	GÜRÜLTÜ SEVİYESİ (db)
PTF 1000T	120x120x58.5	80x80x38 mm	230V-50/60Hz	14 (13)	2800	30	41	0.08 / 0.07	28 (31)

PTF 1000T - 30 m³/h - IP54 **FİYAT: 25.00 \$**

PTF SERİSİ KOLAY MONTAJLI

plastim® FİLTRELİ FANLAR

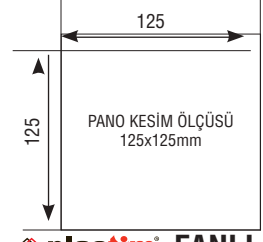
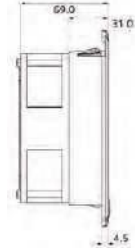

(Klemens Bağlantılı)

plastim® FANLI

KOD	ÖLÇÜLER (mm)	FAN TİPİ	BESLEME (VAC)	GÜÇ (W)	HIZ (rpm)	FİLTRELİ (m ³ /h)	FİLTRESİZ (m ³ /h)	NOMİNAL AKIM (A)	GÜRÜLTÜ SEVİYESİ (db)
PTF 1500T	160x160x69	120x120x38 mm	230V-50/60Hz	26 (23)	2700	100	140	0.14 / 0.13	42 (46)

PTF 1500T - 100 m³/h - IP54

FİYAT: 30.00 \$

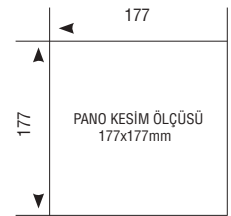
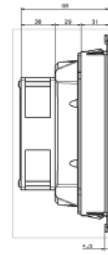
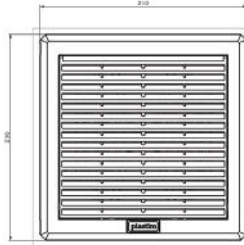

plastim® FANLI

KOD	ÖLÇÜLER (mm)	FAN TİPİ	BESLEME (VAC)	GÜÇ (W)	HIZ (rpm)	FİLTRELİ (m ³ /h)	FİLTRESİZ (m ³ /h)	NOMİNAL AKIM (A)	GÜRÜLTÜ SEVİYESİ (db)
PTF 2000	210x210x98	120x120x38 mm	230V-50/60Hz	26 (23)	2700	125	175	0.14 / 0.13	42 (46)

PTF 2000 - 125 m³/h - IP54

FİYAT: 32.00 \$

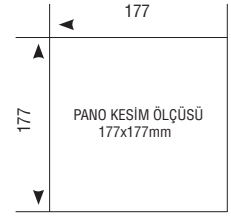
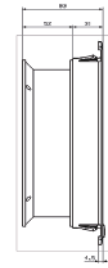
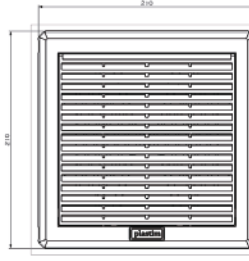

plastim® FANLI

KOD	ÖLÇÜLER (mm)	FAN TİPİ	BESLEME (VAC)	GÜÇ (W)	HIZ (rpm)	FİLTRELİ (m ³ /h)	FİLTRESİZ (m ³ /h)	NOMİNAL AKIM (A)	GÜRÜLTÜ SEVİYESİ (db)
PTF 3000	210x210x83	172x163x51mm	230V-50/60Hz	37 (35)	2400	175	245	0.23 / 0.22	52 (53)

PTF 3000 - 175 m³/h - IP54

FİYAT: 45.00 \$

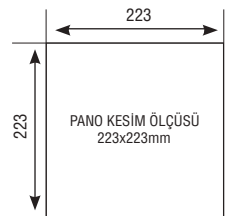
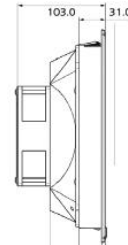
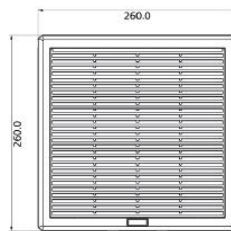

plastim® FANLI

KOD	ÖLÇÜLER (mm)	FAN TİPİ	BESLEME (VAC)	GÜÇ (W)	HIZ (rpm)	FİLTRELİ (m ³ /h)	FİLTRESİZ (m ³ /h)	NOMİNAL AKIM (A)	GÜRÜLTÜ SEVİYESİ (db)
PTF 2500	260x260x103	120x120x38 mm	230V-50/60Hz	26 (23)	2700	115	130	0.14 / 0.13	42 (46)

PTF 2500 - 115 m³/h - IP54

FİYAT: 35.00 \$

PTF SERİSİ KOLAY MONTAJLI

plastim® FİLTRELİ FANLAR

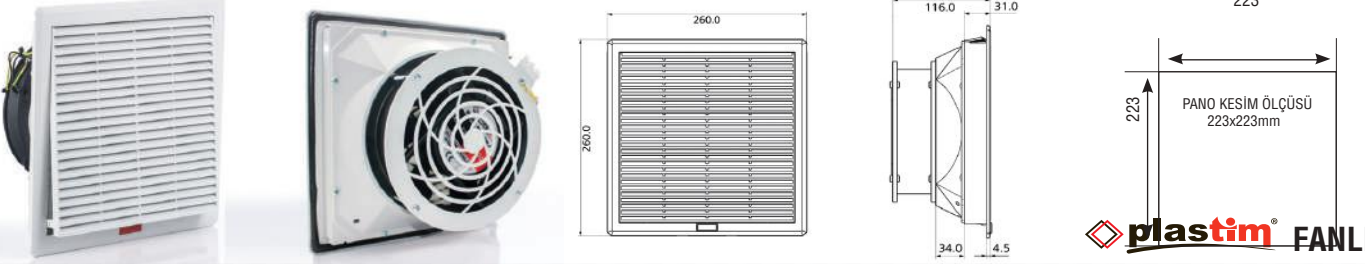

PTF 3500 fan product images and technical drawings showing front view, rear view, and dimensions. The fan is square with a side length of 260.0 mm. The panel cutout size is 223x223 mm. The fan is shown with a filter and without a filter. The fan is labeled 'plastim® FANLI'.

KOD	ÖLÇÜLER (mm)	FAN TİPİ	BESLEME (VAC)	GÜÇ (W)	HIZ (rpm)	FİLTRELİ (m³/h)	FİLTRESİZ (m³/h)	NOMİNAL AKIM (A)	GÜRÜLTÜ SEVİYESİ (db)
PTF 3500	260x260x116	172x163x51 mm	230V-50/60Hz	37 (35)	2400	240	270	0.23 / 0.22	52 (53)

PTF 3500 - 240 m³/h - IP54 **FİYAT: 55.00 \$**

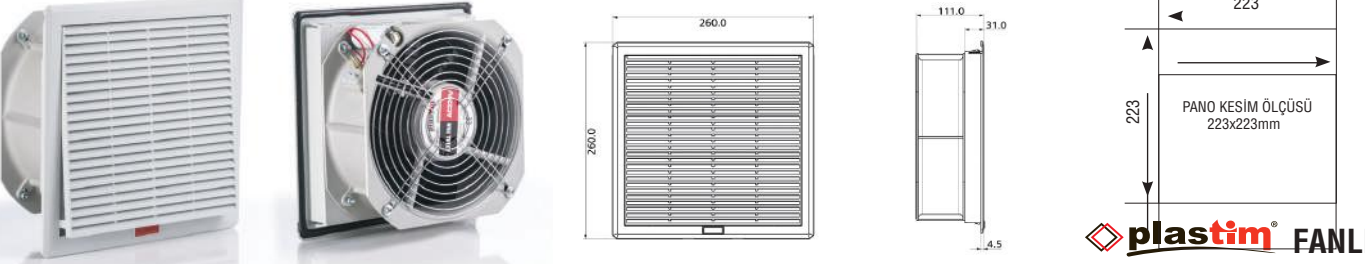

PTF 4500 fan product images and technical drawings showing front view, rear view, and dimensions. The fan is square with a side length of 260.0 mm. The panel cutout size is 223x223 mm. The fan is shown with a filter and without a filter. The fan is labeled 'plastim® FANLI'.

KOD	ÖLÇÜLER (mm)	FAN TİPİ	BESLEME (VAC)	GÜÇ (W)	HIZ (rpm)	FİLTRELİ (m³/h)	FİLTRESİZ (m³/h)	NOMİNAL AKIM (A)	GÜRÜLTÜ SEVİYESİ (db)
PTF 4500	260x260x111	225x225x80 mm	230V-50/60Hz	66 (75)	2600	650	900	0.35 / 0.38	60 (63)

PTF 4500 - 650 m³/h - IP54 **FİYAT: 115.00 \$**

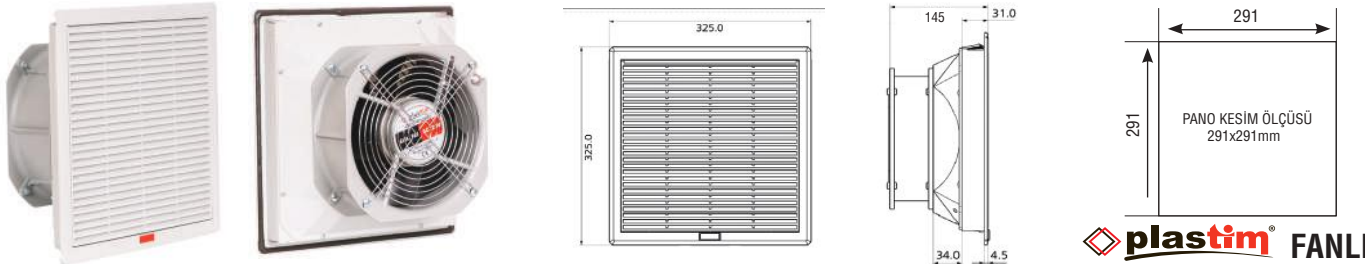

PTF 4700 fan product images and technical drawings showing front view, rear view, and dimensions. The fan is square with a side length of 325.0 mm. The panel cutout size is 291x291 mm. The fan is shown with a filter and without a filter. The fan is labeled 'plastim® FANLI'.

KOD	ÖLÇÜLER (mm)	FAN TİPİ	BESLEME (VAC)	GÜÇ (W)	HIZ (rpm)	FİLTRELİ (m³/h)	FİLTRESİZ (m³/h)	NOMİNAL AKIM (A)	GÜRÜLTÜ SEVİYESİ (db)
PTF4700	325x325x145	225x225x80 mm	230V-50/60Hz	66 (75)	2600	700	950	0.35 / 0.38	60 (63)

PTF 4700 - 700 m³/h - IP54 **FİYAT: 130.00 \$**

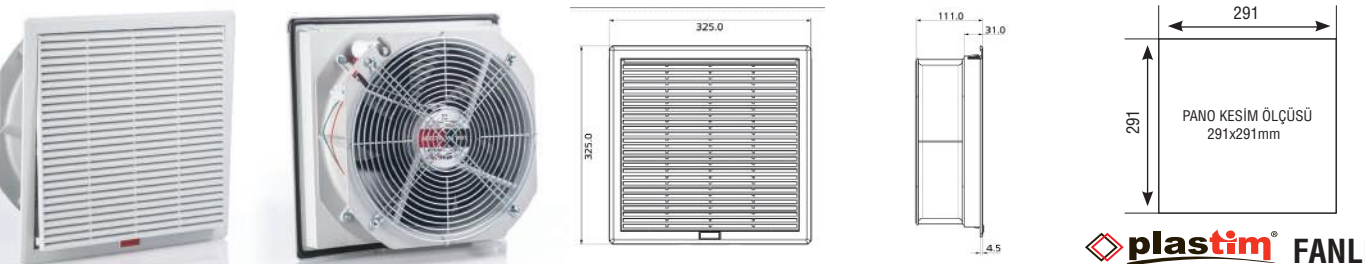

PTF 5000 fan product images and technical drawings showing front view, rear view, and dimensions. The fan is square with a side length of 325.0 mm. The panel cutout size is 291x291 mm. The fan is shown with a filter and without a filter. The fan is labeled 'plastim® FANLI'.

KOD	ÖLÇÜLER (mm)	FAN TİPİ	BESLEME (VAC)	GÜÇ (W)	HIZ (rpm)	FİLTRELİ (m³/h)	FİLTRESİZ (m³/h)	NOMİNAL AKIM (A)	GÜRÜLTÜ SEVİYESİ (db)
PTF 5000	325x325x111	280x280x80 mm	230V-50/60Hz	110 (140)	2600	850	1200	0.50 / 0.72	65 (68)

PTF 5000 - 850 m³/h - IP54 **FİYAT: 145.00 \$**

PTF SERİSİ KOLAY MONTAJLI

plastim® 24v DC FİLTRELİ FANLAR

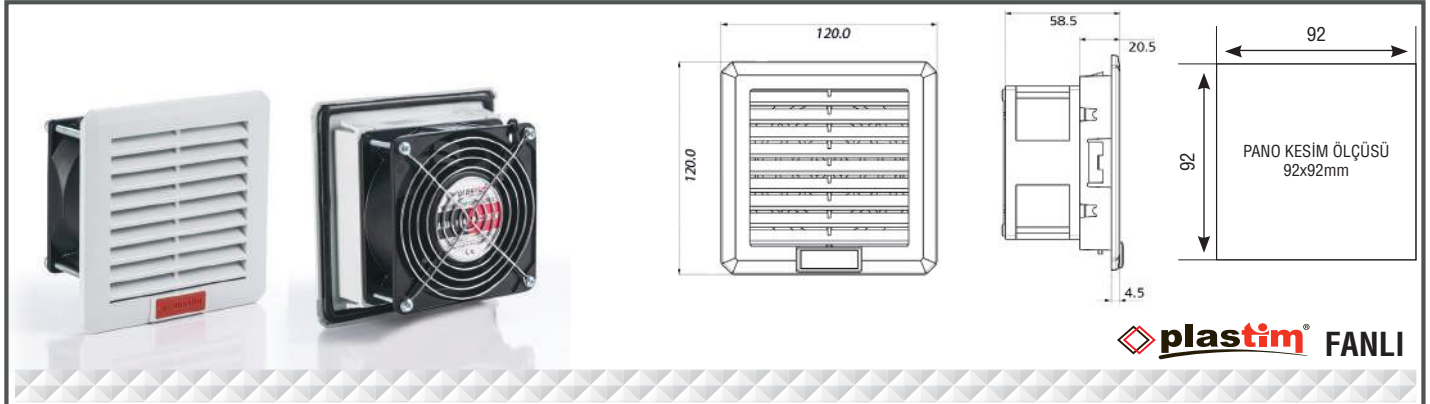

plastim® FANLI

KOD	ÖLÇÜLER (mm)	FAN TİPİ	BESLEME	GÜÇ (W)	HIZ (rpm)	FİLTRELİ (m³/h)	FİLTRESİZ (m³/h)	NOMİNAL AKIM (A)	GÜRÜLTÜ SEVİYESİ (db)
PTF 1000	120x120x58.5	80x80x38 mm	24v DC	14 (13)	2800	30	41	0.08 / 0.07	28 (31)

PTF 1000 24v DC -30 m³/h - IP54

FİYAT: 25.00 \$

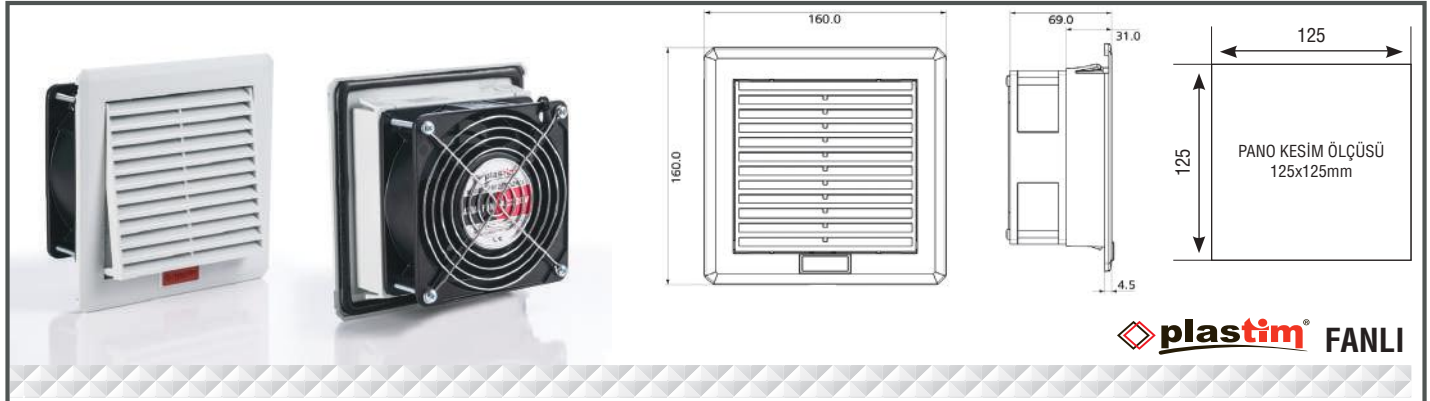

plastim® FANLI

KOD	ÖLÇÜLER (mm)	FAN TİPİ	BESLEME	GÜÇ (W)	HIZ (rpm)	FİLTRELİ (m³/h)	FİLTRESİZ (m³/h)	NOMİNAL AKIM (A)	GÜRÜLTÜ SEVİYESİ (db)
PTF 1500	160x160x69	120x120x38 mm	24v DC	26 (23)	2700	100	140	0.14 / 0.13	42 (46)

PTF 1500 24v DC - 100 m³/h - IP54

FİYAT: 30.00 \$

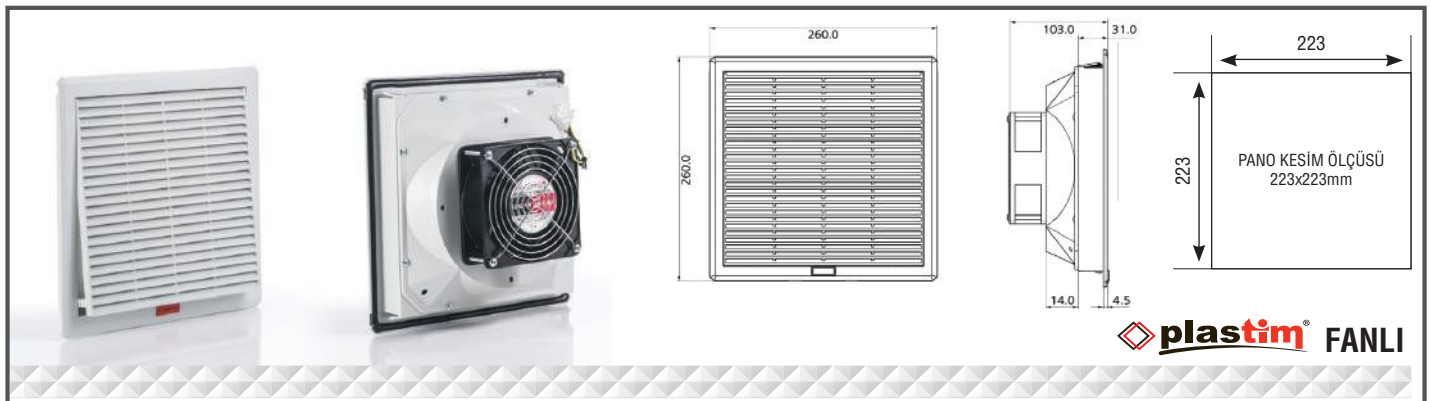

plastim® FANLI

KOD	ÖLÇÜLER (mm)	FAN TİPİ	BESLEME	GÜÇ (W)	HIZ (rpm)	FİLTRELİ (m³/h)	FİLTRESİZ (m³/h)	NOMİNAL AKIM (A)	GÜRÜLTÜ SEVİYESİ (db)
PTF 2500	260x260x103	120x120x38 mm	24v DC	26 (23)	2700	115	130	0.14 / 0.13	42 (46)

PTF 2500 24v DC - 115 m³/h - IP54

FİYAT: 45.00 \$

PTF SERİSİ KOLAY MONTAJLI

plastim® 24v DC FİLTRELİ FANLAR

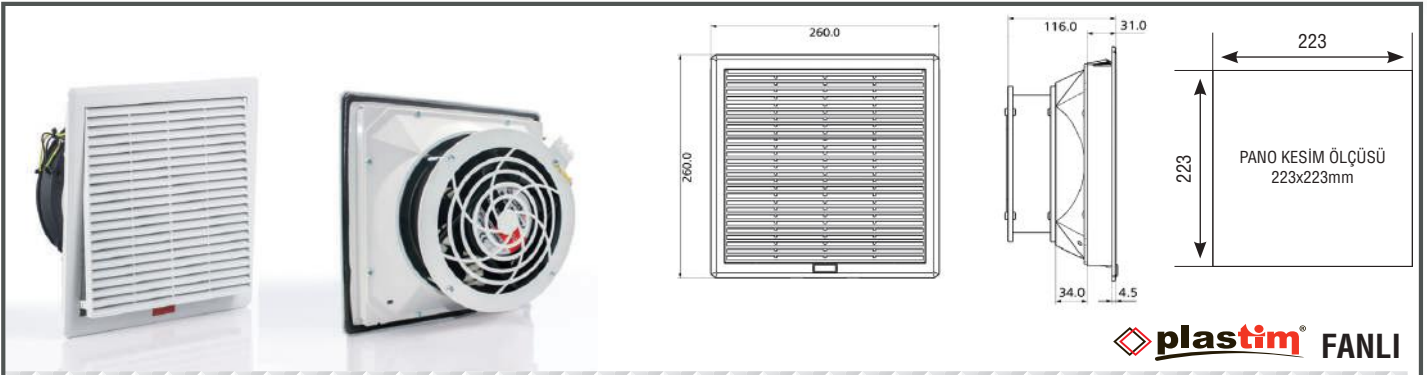

plastim® FANLI

KOD	ÖLÇÜLER (mm)	FAN TİPİ	BESLEME	GÜÇ (W)	HIZ (rpm)	FİLTRELİ (m ³ /h)	FİLTRESİZ (m ³ /h)	NOMİNAL AKIM (A)	GÜRÜLTÜ SEVİYESİ (db)
PTF 3500	260x260x116	172x163x51mm	24v DC	37 (35)	2400	240	270	0.23 / 0.22	52 (53)

PTF 3500 24v DC - 240 m³/h - IP54

FİYAT: 60.00 \$

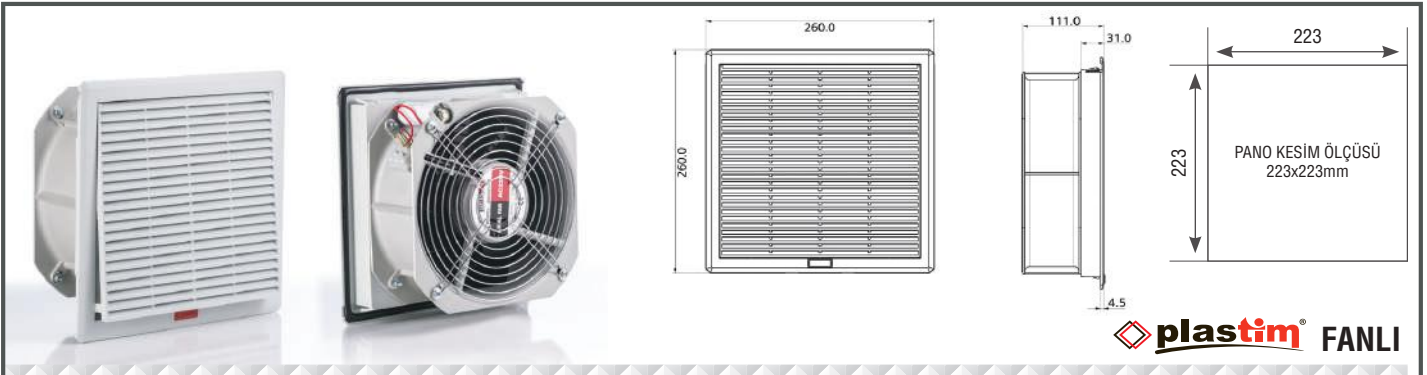

plastim® FANLI

KOD	ÖLÇÜLER (mm)	FAN TİPİ	BESLEME	GÜÇ (W)	HIZ (rpm)	FİLTRELİ (m ³ /h)	FİLTRESİZ (m ³ /h)	NOMİNAL AKIM (A)	GÜRÜLTÜ SEVİYESİ (db)
PTF 4500	260x260x111	225x225x80mm	24v DC	66 (75)	2600	650	900	0.35 / 0.38	60 (63)

PTF 4500 24v DC - 650 m³/h - IP54

FİYAT: 185.00 \$

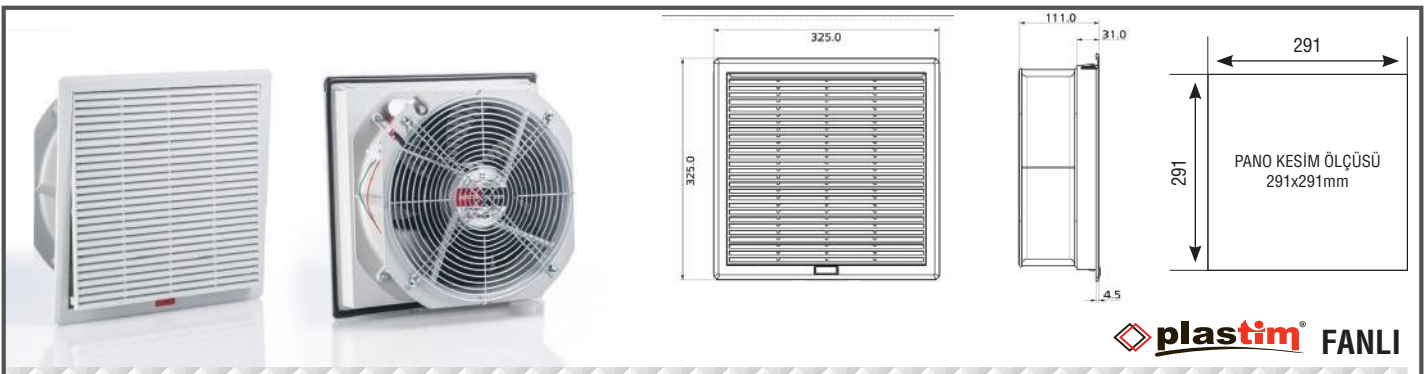

plastim® FANLI

KOD	ÖLÇÜLER (mm)	FAN TİPİ	BESLEME	GÜÇ (W)	HIZ (rpm)	FİLTRELİ (m ³ /h)	FİLTRESİZ (m ³ /h)	NOMİNAL AKIM (A)	GÜRÜLTÜ SEVİYESİ (db)
PTF 5000	325x325x111	280x280x80mm	24v DC	110 (140)	2600	850	1200	0.50 / 0.72	65 (68)

PTF 5000 24v DC - 850 m³/h - IP54

FİYAT: 198.00 \$

PTS SERİSİ KOLAY MONTAJLI FİLTRELİ FANLAR



FİLTRELİ FANLAR

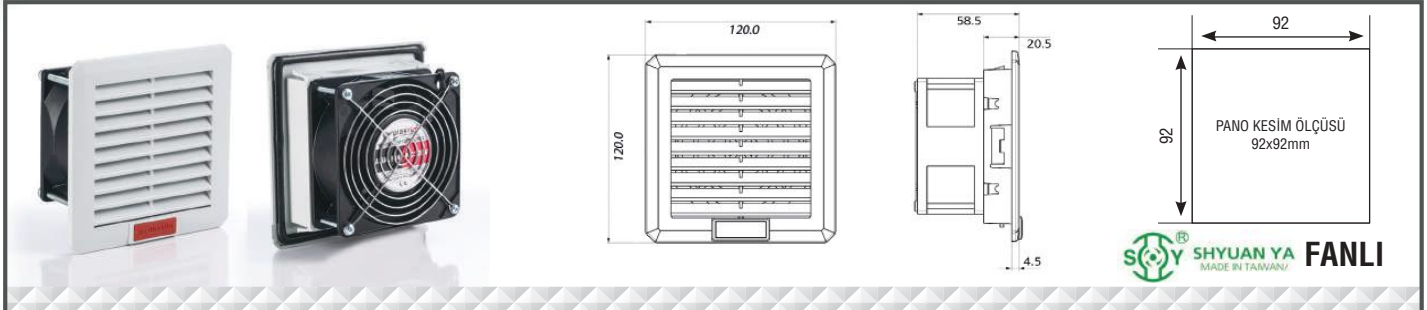

SHYUAN YA FANLI
MADE IN TAIWAN

KOD	ÖLÇÜLER (mm)	FAN TİPİ	BESLEME (VAC)	GÜÇ (W)	HIZ (rpm)	FİLTRELİ (m ³ /h)	FİLTRESİZ (m ³ /h)	NOMİNAL AKIM (A)	GÜRÜLTÜ SEVİYESİ (db)
PTS 1000	120x120x58.5	80x80x38 mm	230V-50/60Hz	14 (13)	2800	30	41	0.08 / 0.07	28 (31)

PTS 1000 - 30 m³/h - IP54

FİYAT: 35.00 \$

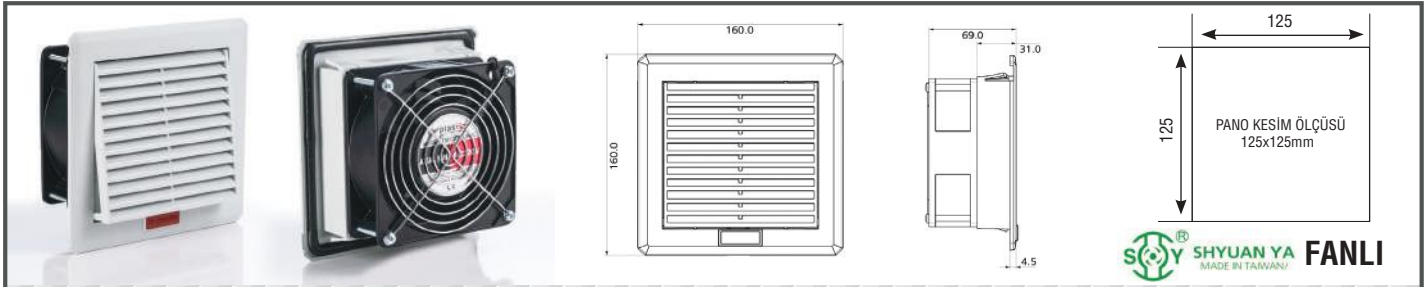

SHYUAN YA FANLI
MADE IN TAIWAN

KOD	ÖLÇÜLER (mm)	FAN TİPİ	BESLEME (VAC)	GÜÇ (W)	HIZ (rpm)	FİLTRELİ (m ³ /h)	FİLTRESİZ (m ³ /h)	NOMİNAL AKIM (A)	GÜRÜLTÜ SEVİYESİ (db)
PTS 1500	160x160x69	120x120x38 mm	230V-50/60Hz	26 (23)	2700	100	140	0.14 / 0.13	42 (46)

PTS 1500 - 100 m³/h - IP54

FİYAT: 40.00 \$

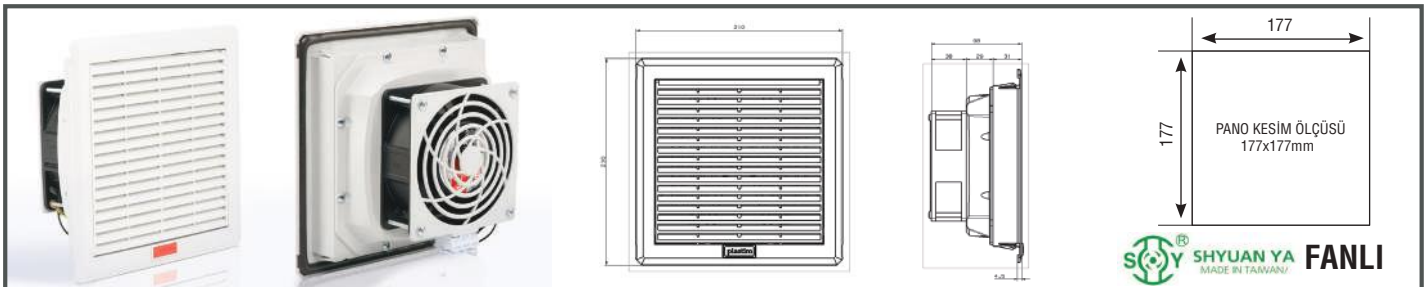

SHYUAN YA FANLI
MADE IN TAIWAN

KOD	ÖLÇÜLER (mm)	FAN TİPİ	BESLEME (VAC)	GÜÇ (W)	HIZ (rpm)	FİLTRELİ (m ³ /h)	FİLTRESİZ (m ³ /h)	NOMİNAL AKIM (A)	GÜRÜLTÜ SEVİYESİ (db)
PTS 2000	160x160x69	120x120x38 mm	230V-50/60Hz	26 (23)	2700	125	175	0.14 / 0.13	42 (46)

PTS 2000 - 125 m³/h - IP54

FİYAT: 62.00 \$

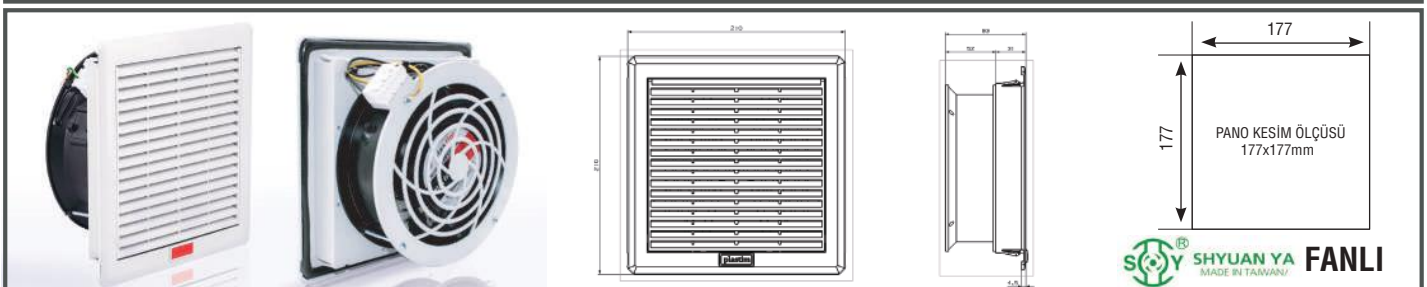

SHYUAN YA FANLI
MADE IN TAIWAN

KOD	ÖLÇÜLER (mm)	FAN TİPİ	BESLEME (VAC)	GÜÇ (W)	HIZ (rpm)	FİLTRELİ (m ³ /h)	FİLTRESİZ (m ³ /h)	NOMİNAL AKIM (A)	GÜRÜLTÜ SEVİYESİ (db)
PTS 3000	160x160x69	120x120x38 mm	230V-50/60Hz	26 (23)	2700	175	245	0.14 / 0.13	42 (46)

PTS 3000 - 175 m³/h - IP54

FİYAT: 72.00 \$

PTS SERİSİ KOLAY MONTAJLI



FİLTRELİ FANLAR

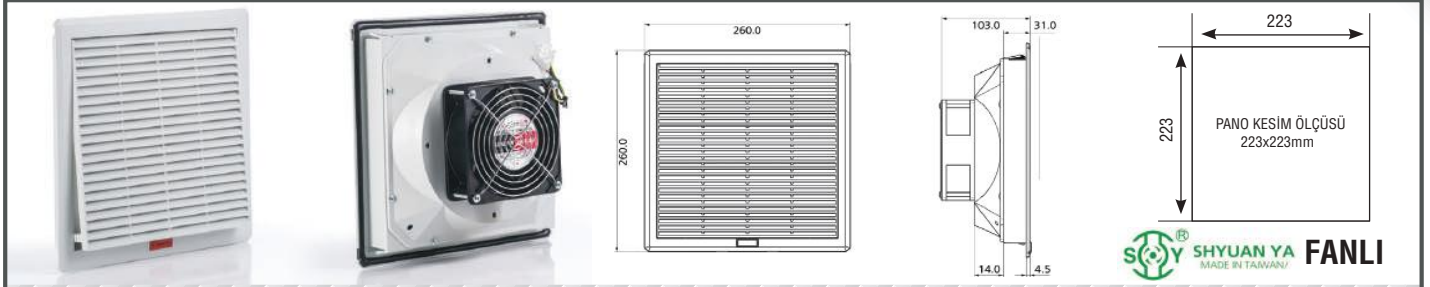

SHYUAN YA FANLI
MADE IN TAIWAN

KOD	ÖLÇÜLER (mm)	FAN TİPİ	BESLEME (VAC)	GÜÇ (W)	HIZ (rpm)	FİLTRELİ (m³/h)	FİLTRESİZ (m³/h)	NOMİNAL AKIM (A)	GÜRÜLTÜ SEVİYESİ (db)
PTS 2500	260x260x103	120x120x38 mm	230V-50/60Hz	26 (23)	2700	115	130	0.14 / 0.13	42 (46)

PTS 2500 - 115 m³/h - IP54

FİYAT: 65.00 \$

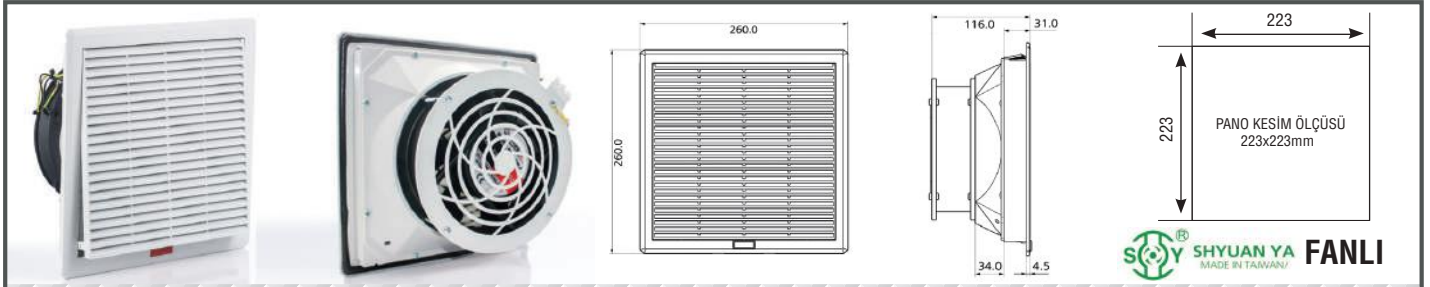

SHYUAN YA FANLI
MADE IN TAIWAN

KOD	ÖLÇÜLER (mm)	FAN TİPİ	BESLEME (VAC)	GÜÇ (W)	HIZ (rpm)	FİLTRELİ (m³/h)	FİLTRESİZ (m³/h)	NOMİNAL AKIM (A)	GÜRÜLTÜ SEVİYESİ (db)
PTS 3500	260x260x116	172x163x51 mm	230V-50/60Hz	37 (35)	2400	240	270	0.23 / 0.22	52 (53)

PTS 3500 - 240 m³/h - IP54

FİYAT: 70.00 \$

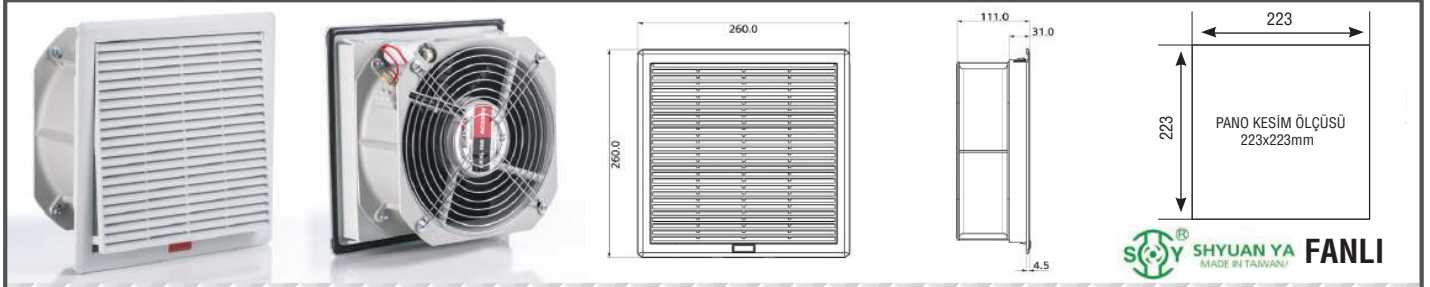

SHYUAN YA FANLI
MADE IN TAIWAN

KOD	ÖLÇÜLER (mm)	FAN TİPİ	BESLEME (VAC)	GÜÇ (W)	HIZ (rpm)	FİLTRELİ (m³/h)	FİLTRESİZ (m³/h)	NOMİNAL AKIM (A)	GÜRÜLTÜ SEVİYESİ (db)
PTS 4500	260x260x111	225x225x80 mm	230V-50/60Hz	66 (75)	2600	650	900	0.35 / 0.38	60 (63)

PTS 4500 - 650 m³/h - IP54

FİYAT: 160.00 \$

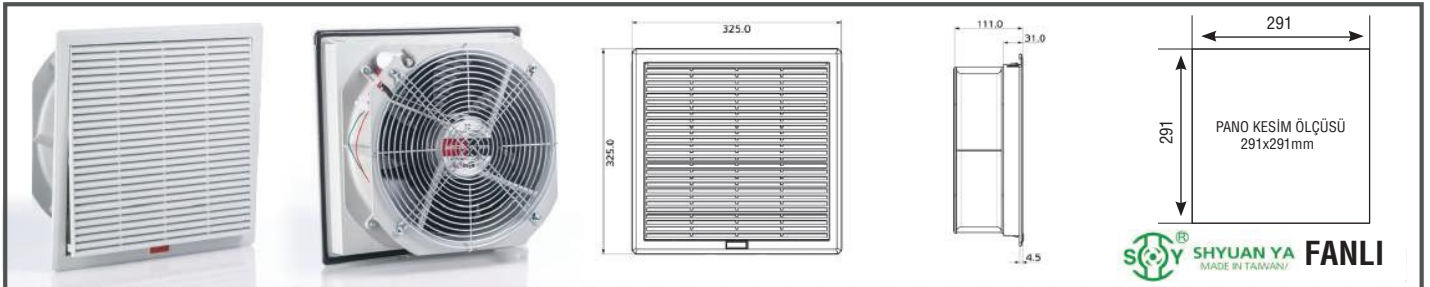

SHYUAN YA FANLI
MADE IN TAIWAN

KOD	ÖLÇÜLER (mm)	FAN TİPİ	BESLEME (VAC)	GÜÇ (W)	HIZ (rpm)	FİLTRELİ (m³/h)	FİLTRESİZ (m³/h)	NOMİNAL AKIM (A)	GÜRÜLTÜ SEVİYESİ (db)
PTS 5000	325x325x111	280x280x80 mm	230V-50/60Hz	110 (140)	2600	850	1200	0.50 / 0.72	65 (68)

PTS 5000 - 850 m³/h - IP54

FİYAT: 185.00 \$

ENDÜSTRİYEL FANLAR



ENDÜSTRİYEL FANLAR - DC BESLEME



80x80x25 mm
12VDC
Bilezikli

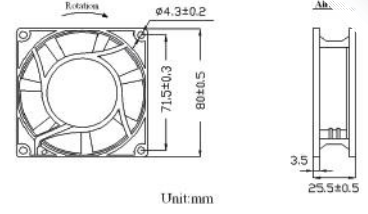

KOD Birim	BESLEME V	FREKANS Hz	YATAKLAMA -	AKIM A	GÜÇ W	HIZ Rpm	KAPASİTE m³/h	GÜRÜLTÜ dB(A)	AĞIRLIK g
PF08025B12	12VDC	-	Bilezik	0.18	2.16	3000	66	36	80

PF08025B12 - AKSİYEL FAN

FİYAT: 3.50 \$



**Made in
Taiwan**

80x80x38 mm
24VDC
Bilezikli

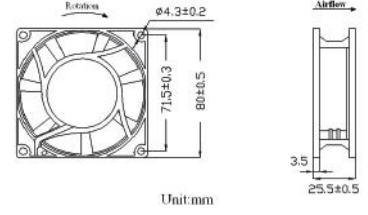

KOD Birim	BESLEME V	FREKANS Hz	YATAKLAMA -	AKIM A	GÜÇ W	HIZ Rpm	KAPASİTE m³/h	GÜRÜLTÜ dB(A)	AĞIRLIK g
PF08038B24T	24VDC	-	Bilezik	0.18	2.16	3000	66	36	80

PF08038B24T - AKSİYEL FAN

FİYAT: 22.00 \$



120x120x38 mm
12VDC
Bilezikli

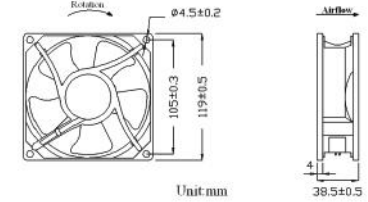

KOD Birim	BESLEME V	FREKANS Hz	YATAKLAMA -	AKIM A	GÜÇ W	HIZ Rpm	KAPASİTE m³/h	GÜRÜLTÜ dB(A)	AĞIRLIK g
PF12038B12	12VDC	-	Bilezik	0.34	4.08	2500	162	40	250

PF12038B12 - AKSİYEL FAN

FİYAT: 12.00 \$



**Made in
Taiwan**

120x120x38 mm
24VDC
Bilezikli

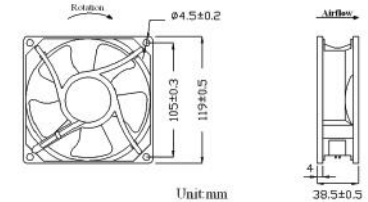

KOD Birim	BESLEME V	FREKANS Hz	YATAKLAMA -	AKIM A	GÜÇ W	HIZ Rpm	KAPASİTE m³/h	GÜRÜLTÜ dB(A)	AĞIRLIK g
PF12038B24T	24VDC	-	Bilezik	0.20	4.80	2500	162	40	250

PF12038B24T - AKSİYEL FAN

FİYAT: 18.00 \$

ENDÜSTRİYEL FANLAR - DC BESLEME



120x120x38 mm
48VDC
Bilezikli

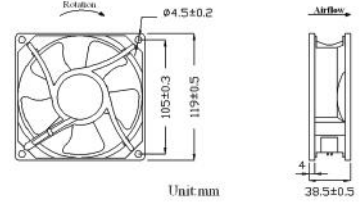

KOD Birim	BESLEME V	FREKANS Hz	YATAKLAMA -	AKIM A	GÜÇ W	HIZ Rpm	KAPASİTE m³/h	GÜRÜLTÜ dB(A)	AĞIRLIK g
PF12038B48	48VDC	-	Bilezik	0.18	8.64	2500	162	40	250

PF12038B48 - AKSİYEL FAN

FİYAT: 12.00 \$



172x150x51 mm
24VDC
Rulmanlı

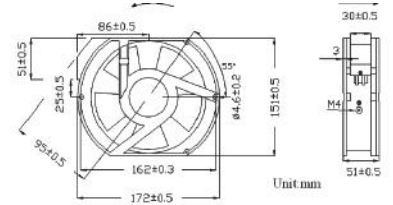

KOD Birim	BESLEME V	FREKANS Hz	YATAKLAMA -	AKIM A	GÜÇ W	HIZ Rpm	KAPASİTE m³/h	GÜRÜLTÜ dB(A)	AĞIRLIK g
PF17250R24	24VDC	-	Rulman	0.65	15.60	2400	272	47	800

PF17250R24 - AKSİYEL FAN

FİYAT: 22.00 \$



225x225x80 mm
24VDC
Rulmanlı

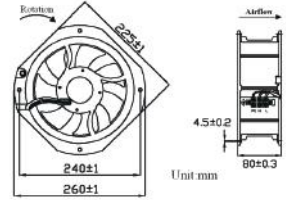

KOD Birim	BESLEME V	FREKANS Hz	YATAKLAMA -	AKIM A	GÜÇ W	HIZ Rpm	KAPASİTE m³/h	GÜRÜLTÜ dB(A)	AĞIRLIK g
PF22580R24	24VDC	-	Rulman	0.35	75	2600	1020	65	1920

PF22580R24- AKSİYEL FAN

FİYAT: 154.00 \$



280x280x80 mm
24VDC
Rulmanlı

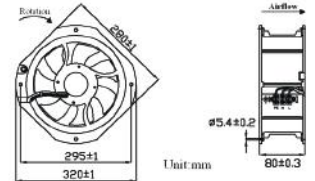

KOD Birim	BESLEME V	FREKANS Hz	YATAKLAMA -	AKIM A	GÜÇ W	HIZ Rpm	KAPASİTE m³/h	GÜRÜLTÜ dB(A)	AĞIRLIK g
PF28080R24	24VDC	-	Rulman	0.37	130	2600	1800/1980	68	2760

PF28080R24- AKSİYEL FAN

FİYAT: 166.00 \$

ENDÜSTRİYEL FANLAR - 110V AC BESLEME



80x80x25 mm
110VAC 50/60 Hz
Bilezikli

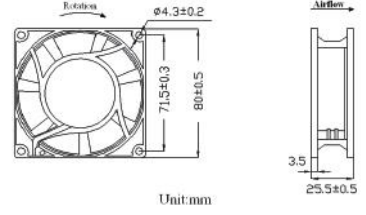

Unit:mm

KOD Birim	BESLEME V	FREKANS Hz	YATAKLAMA -	AKIM A	GÜÇ W	HIZ Rpm	KAPASİTE m³/h	GÜRÜLTÜ dB(A)	AĞIRLIK g
PF8025B	110VAC	50/60	Bilezikli	0.13/0.12	13/12	2450	27/31	28/29	230

PF8025B - AKSİYEL FAN

FİYAT: 6.00 \$



120x120x38 mm
110VAC 50/60 Hz
Bilezikli

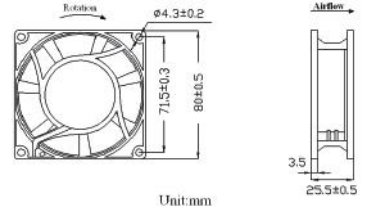

Unit:mm

KOD Birim	BESLEME V	FREKANS Hz	YATAKLAMA -	AKIM A	GÜÇ W	HIZ Rpm	KAPASİTE m³/h	GÜRÜLTÜ dB(A)	AĞIRLIK g
PF12038B	110VAC	50/60	Bilezikli	0.24/0.23	26/23	2800	153/170	42/46	500

PF12038B - AKSİYEL FAN

FİYAT: 10.00 \$



225x225x80 mm
110VAC 50/60 Hz
Rulmanlı

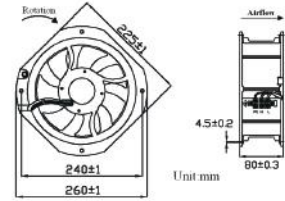

Unit:mm

KOD Birim	BESLEME V	FREKANS Hz	YATAKLAMA -	AKIM A	GÜÇ W	HIZ Rpm	KAPASİTE m³/h	GÜRÜLTÜ dB(A)	AĞIRLIK g
PF22580R	110VAC	50/60	Rulman	0.35	75	2600	1020	65	1920

PF22580R - AKSİYEL FAN

FİYAT: 115.00 \$



280x280x80 mm
110VAC 50/60 Hz
Rulmanlı

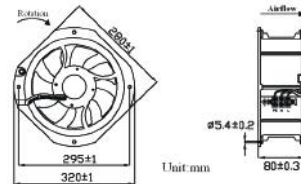

Unit:mm

KOD Birim	BESLEME V	FREKANS Hz	YATAKLAMA -	AKIM A	GÜÇ W	HIZ Rpm	KAPASİTE m³/h	GÜRÜLTÜ dB(A)	AĞIRLIK g
PF28080R	110VAC	50/60	Rulman	0.37	130	2600	1800/1980	68	2760

PF28080R - AKSİYEL FAN

FİYAT: 150.00 \$

ENDÜSTRİYEL FANLAR 220V - AC BESLEME



80x80x25 mm
220VAC 50/60 Hz
Bilezikli

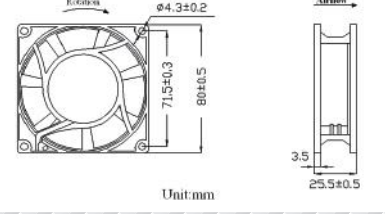

Unit:mm

KOD Birim	BESLEME V	FREKANS Hz	YATAKLAMA -	AKIM A	GÜÇ W	HIZ Rpm	KAPASİTE m³/h	GÜRÜLTÜ dB(A)	AĞIRLIK g
PF8025B	220VAC	50/60	Bilezikli	0.08/0.07	13/12	2450	27/31	28/29	230

PF8025B - AKSİYEL FAN

FİYAT: 6.00 \$



80x80x38 mm
220VAC 50/60 Hz
Bilezikli

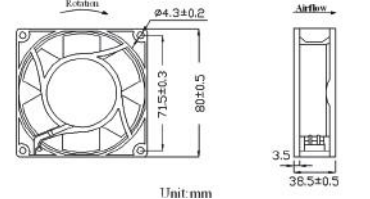

Unit:mm

KOD Birim	BESLEME V	FREKANS Hz	YATAKLAMA -	AKIM A	GÜÇ W	HIZ Rpm	KAPASİTE m³/h	GÜRÜLTÜ dB(A)	AĞIRLIK g
PF8038B	220VAC	50/60	Bilezikli	0.08/0.07	14/13	2400	44/51	28/31	340

PF8038B - AKSİYEL FAN

FİYAT: 6.00 \$



120x120x25 mm
220VAC 50/60 Hz
Bilezikli

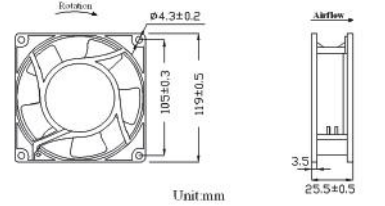

Unit:mm

KOD Birim	BESLEME V	FREKANS Hz	YATAKLAMA -	AKIM A	GÜÇ W	HIZ Rpm	KAPASİTE m³/h	GÜRÜLTÜ dB(A)	AĞIRLIK g
PF12025B	220VAC	50/60	Bilezikli	0.08/0.07	16/15	2400	72/77	40/41	380

PF12025B - AKSİYEL FAN

FİYAT: 6.00 \$



120x120x38 mm
220VAC 50/60 Hz
Bilezikli

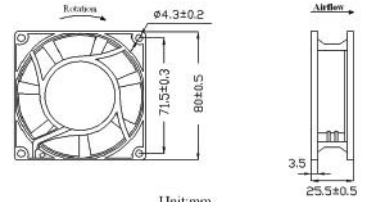

Unit:mm

KOD Birim	BESLEME V	FREKANS Hz	YATAKLAMA -	AKIM A	GÜÇ W	HIZ Rpm	KAPASİTE m³/h	GÜRÜLTÜ dB(A)	AĞIRLIK g
PF12038B	220VAC	50/60	Bilezikli	0.14/0.13	26/23	2700	153/170	42/46	500

PF12038B - AKSİYEL FAN

FİYAT: 6.00 \$

ENDÜSTRİYEL FANLAR 220V - AC BESLEME



120x120x38 mm
220VAC 50/60 Hz
Rulmanlı

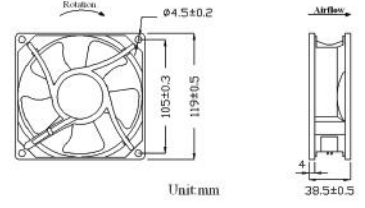

KOD Birim	BESLEME V	FREKANS Hz	YATAKLAMA -	AKIM A	GÜÇ W	HIZ Rpm	KAPASİTE m³/h	GÜRÜLTÜ dB(A)	AĞIRLIK g
PF12038R	220VAC	50/60	Rulman	0.14/0.13	26/23	2700	153/170	42/46	50

PF12038R - AKSİYEL FAN

FİYAT: 11.00 \$



172x150x51 mm
220VAC 50/60 Hz
Rulmanlı

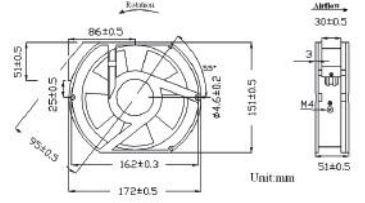

KOD Birim	BESLEME V	FREKANS Hz	YATAKLAMA -	AKIM A	GÜÇ W	HIZ Rpm	KAPASİTE m³/h	GÜRÜLTÜ dB(A)	AĞIRLIK g
PF17250R	220VAC	50/60	Rulman	0.23/0.22	37/35	2500	255/289	52/53	950

PF17250R - AKSİYEL FAN

FİYAT: 20.00 \$



172x163x51 mm
220VAC 50/60 Hz
Rulmanlı

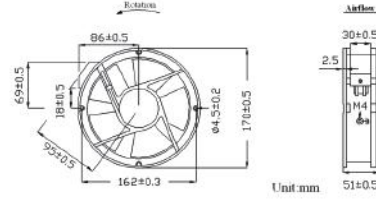

KOD Birim	BESLEME V	FREKANS Hz	YATAKLAMA -	AKIM A	GÜÇ W	HIZ Rpm	KAPASİTE m³/h	GÜRÜLTÜ dB(A)	AĞIRLIK g
PF17260R	220VAC	50/60	Rulman	0.23/0.22	37/35	2400	255/289	52/53	950

PF17260R - AKSİYEL FAN

FİYAT: 20.00 \$



Ø220x60 mm
220VAC 50/60 Hz
Rulmanlı

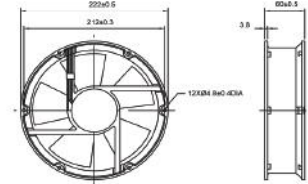

KOD Birim	BESLEME V	FREKANS Hz	YATAKLAMA -	AKIM A	GÜÇ W	HIZ Rpm	KAPASİTE m³/h	GÜRÜLTÜ dB(A)	AĞIRLIK g
PF22060R	220VAC	50/60	Rulman	0.31/0.30	56/54	2100	290/305	64/66	1700

PF22060R - AKSİYEL FAN

FİYAT: 38.00 \$

ENDÜSTRİYEL FANLAR 220V - AC BESLEME



225x225x80 mm
220VAC 50/60 Hz
Rulmanlı

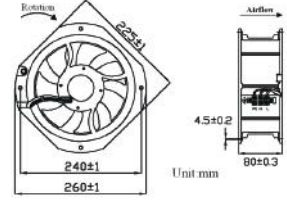

Unit mm

KOD Birim	BESLEME V	FREKANS Hz	YATAKLAMA -	AKIM A	GÜÇ W	HIZ Rpm	KAPASİTE m ³ /h	GÜRÜLTÜ dB(A)	AĞIRLIK g
PF22580R	220VAC	50/60	Rulman	0.35	75	2600	1020	65	1920

PF22580R - AKSİYEL FAN

FİYAT: 95.00 \$



280x280x80 mm
220VAC 50/60 Hz
Rulmanlı

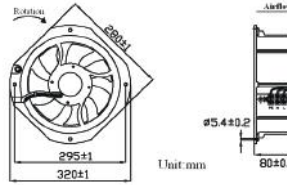

Unit mm

KOD Birim	BESLEME V	FREKANS Hz	YATAKLAMA -	AKIM A	GÜÇ W	HIZ Rpm	KAPASİTE m ³ /h	GÜRÜLTÜ dB(A)	AĞIRLIK g
PF28080R	220VAC	50/60	Rulman	0.37	130	2600	1800/1980	68	2760

PF28080R - AKSİYEL FAN

FİYAT: 125.00 \$





225x225x80 mm
220VAC 50/60 Hz
Rulmanlı

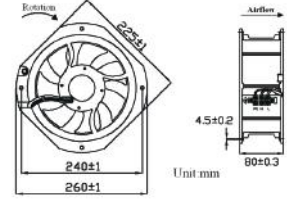

KOD Birim	BESLEME V	FREKANS Hz	YATAKLAMA -	AKIM A	GÜÇ W	HIZ Rpm	KAPASİTE m³/h	GÜRÜLTÜ dB(A)	AĞIRLIK g
AA2V200-80T	230VAC	50/60	Rulman	0.33	66	2600	1020	60	1920

PF22580R - AKSİYEL FAN

FİYAT: 115.00 \$



280x280x80 mm
220VAC 50/60 Hz
Rulmanlı

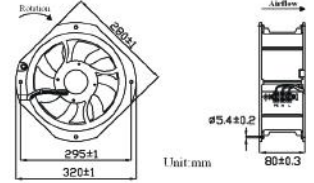

KOD Birim	BESLEME V	FREKANS Hz	YATAKLAMA -	AKIM A	GÜÇ W	HIZ Rpm	KAPASİTE m³/h	GÜRÜLTÜ dB(A)	AĞIRLIK g
AA2V250-80T	230VAC	50/60	Rulman	0.57	130	2600	1800/1980	68	2760

PF28080R - AKSİYEL FAN

FİYAT: 135.00 \$



Ø190x69 mm
220VAC 50/60 Hz
Rulmanlı

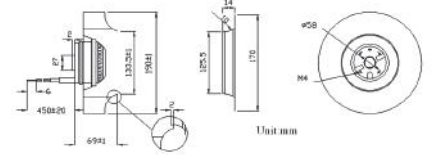

KOD Birim	BESLEME V	FREKANS Hz	YATAKLAMA -	AKIM A	GÜÇ W	HIZ Rpm	KAPASİTE m³/h	GÜRÜLTÜ dB(A)	AĞIRLIK g
BA2V190-69T	220VAC	50/60	Rulman	0.27/0.33	60/73	2600	582/642	63/66	1360

BA2V190-69T - RADYAL FAN

FİYAT: 80.00 \$



Ø220x71 mm
220VAC 50/60 Hz
Rulmanlı

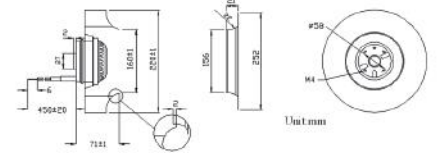

KOD Birim	BESLEME V	FREKANS Hz	YATAKLAMA -	AKIM A	GÜÇ W	HIZ Rpm	KAPASİTE m³/h	GÜRÜLTÜ dB(A)	AĞIRLIK g
BA2V220-71T	220VAC	50/60	Rulman	0.39/0.40	81/92	2600	980/1020	66/70	1410

BA2V220-71T - RADYAL FAN

FİYAT: 90.00 \$



60x60x30 mm
220VAC 50/60 Hz
Rulmanlı

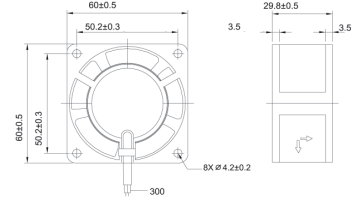

KOD Birim	BESLEME V	FREKANS Hz	YATAKLAMA -	AKIM A	GÜÇ W	HIZ Rpm	KAPASİTE m³/h	GÜRÜLTÜ dB(A)	AĞIRLIK g
A6030V2HBL	220VAC	50/60	Rulman	0.02/0.01	5/4	3000	14/16	27/28	140

A6030V2HBL - AKSİYEL FAN

FİYAT: 27.00 \$



120x120x38 mm
220VAC 50/60 Hz
Bilezikli

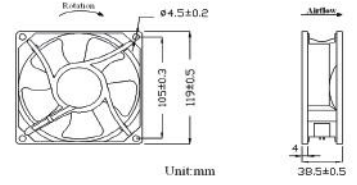

KOD Birim	BESLEME V	FREKANS Hz	YATAKLAMA -	AKIM A	GÜÇ W	HIZ Rpm	KAPASİTE m³/h	GÜRÜLTÜ dB(A)	AĞIRLIK g
A2V12C38T	220VAC	50/60	Bilezikli	0.13/0.10	20/16	2600	144/168	44/48	515

A2V12C38T - AKSİYEL FAN

FİYAT: 14.00 \$



172x150x51 mm
220VAC 50/60 Hz
Rulmanlı

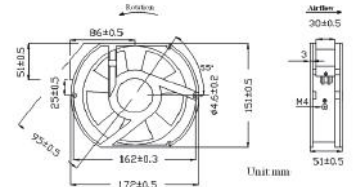

KOD Birim	BESLEME V	FREKANS Hz	YATAKLAMA -	AKIM A	GÜÇ W	HIZ Rpm	KAPASİTE m³/h	GÜRÜLTÜ dB(A)	AĞIRLIK g
A2V17C51T	220VAC	50/60	Rulman	0.11/0.15	25/32	2600	336/390	57/61	875

A2V17C51T - AKSİYEL FAN

FİYAT: 42.00 \$



172x150x55 mm
220VAC 50/60 Hz
Rulmanlı

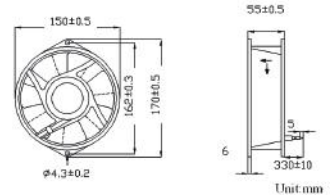

KOD Birim	BESLEME V	FREKANS Hz	YATAKLAMA -	AKIM A	GÜÇ W	HIZ Rpm	KAPASİTE m³/h	GÜRÜLTÜ dB(A)	AĞIRLIK g
A2V15C55T	220VAC	50/60	Rulman	0.17/0.19	37/43	3000	342/410	57/61	1000

A2V15C55T - AKSİYEL FAN

FİYAT: 68.00 \$

AKSESUARLAR

FAN TELLERİ

PT0808

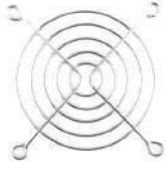

PT1212



PT1717



PT2020



PT2525



KOD	AÇIKLAMA	PAKET ADEDİ	FİYAT
PT0606	METAL KORUMA TELİ 60x60mm için	100	0.50 \$
PT0808	METAL KORUMA TELİ 80x80mm için	100	0.50 \$
PT1212	METAL KORUMA TELİ 120x120mm için	100	0.80 \$
PT1717	METAL KORUMA TELİ 170x170mm için	100	1.00 \$
PT2020	METAL KORUMA TELİ 225x225mm için	100	2.50 \$
PT2525	METAL KORUMA TELİ 280x280mm için	100	8.00 \$



FİLTRE ÜNİTESİ

KOD	AÇIKLAMA	PAKET ADEDİ	FİYAT
PFM1000	FİLTRE ÜNİTESİ PFI 1000 için	10	26.00 TL
PFM1500	FİLTRE ÜNİTESİ PFI 1500 için	10	32.50 TL
PFM2500	FİLTRE ÜNİTESİ PFI 2500 için	10	76.00 TL
PFM3000	FİLTRE ÜNİTESİ PFI 3000 için	10	188.00 TL



PROJE CEPLERİ

AÇIKLAMA	PAKET ADEDİ	FİYAT
PPCA4 Proje Cebi A4	10	18.00 TL

AÇIKLAMA	PAKET ADEDİ	FİYAT
PPCA5 Proje Cebi A5	10	14.50 TL

İZOLELİ KABLO UÇLARI

İZOLELİ KABLO YÜKSÜKLERİ ALMAN NORMU

ÜRÜN KODU	RENK	KABLO KESİTİ	EBATLAR					KUTU ADETİ	LİSTE FİYATI
			[F]	[L]	[W]	[B]	[D]		
PKY-2005		0,50	8	14	2,6	6,0	1,3	1000	0.059 TL
PKY-2007		0,75	8	14	2,8	6,3	1,5	1000	0.059 TL
PKY-2010		1,00	8	14	3,0	6,3	1,7	1000	0.059 TL
PKY-2015		1,50	8	14	3,5	6,3	2,0	1000	0.059 TL
PKY-2025		2,50	8	14	4,2	7,4	2,5	500	0.065 TL
PKY-2040		4,00	10	17	4,8	7,4	3,2	500	0.117 TL
PKY-2060		6,00	12	20	6,3	8,5	3,9	250	0.150 TL
PKY-2100		10,00	12	22	7,6	8,8	4,9	100	0.182 TL
PKY-2160		16,00	12	24	8,8	10,0	6,2	100	0.260 TL
PKY-2250		25,00	16	28	11,2	12,0	7,7	50	0.475 TL
PKY-2350		35,00	16	30	12,7	14,0	8,7	50	0.605 TL
PKY-2500		50,00	20	36	15,0	16,0	10,9	25	0.962 TL











İZOLELİ KABLO YÜKSÜKLERİ FRANSIZ NORMU

ÜRÜN KODU	RENK	KABLO KESİTİ	EBATLAR					KUTU ADETİ	LİSTE FİYATI
			[F]	[L]	[W]	[B]	[D]		
PKY-3005		0,50	8	14	2,6	6,0	1,3	1000	0.059 TL
PKY-3007		0,75	8	14	2,8	6,3	1,5	1000	0.059 TL
PKY-3010		1,00	8	14	3,0	6,3	1,7	1000	0.059 TL
PKY-3015		1,50	8	14	3,5	6,3	2,0	1000	0.059 TL
PKY-3025		2,50	8	14	4,2	7,4	2,5	500	0.065 TL
PKY-3040		4,00	10	17	4,8	7,4	3,2	500	0.117 TL
PKY-3060		6,00	12	20	6,3	8,5	3,9	250	0.150 TL
PKY-3100		10,00	12	22	7,6	8,8	4,9	100	0.182 TL
PKY-3160		16,00	12	24	8,8	10,0	6,2	100	0.260 TL
PKY-3250		25,00	16	28	11,2	12,0	7,7	50	0.475 TL
PKY-3350		35,00	16	30	12,7	14,0	8,7	50	0.605 TL
PKY-3500		50,00	20	36	15,0	16,0	10,9	25	0.962 TL







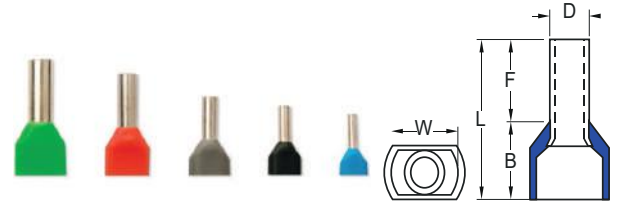

İZOLELİ KABLO UÇLARI

ÇİFT GİRİŞLİ İZOLELİ KABLO YÜKSÜKLERİ ALMAN NORMU

ÜRÜN KODU	RENK	KABLO KESİTİ	EBATLAR					KUTU ADETİ	LİSTE FİYATI
			[F]	[L]	[W]	[B]	[D]		
PKY-22005		2x0,50	8	14	5,0	6,5	1,8	1000	0.105 TL
PKY-22007		2x0,75	8	14	5,5	6,7	2,1	500	0.105 TL
PKY-22010		2x1,00	8	14	5,5	7,1	2,4	500	0.105 TL
PKY-22015		2x1,50	8	14	6,4	7,5	2,6	500	0.111 TL
PKY-22025		2x2,50	10	14	8,0	8,5	3,3	250	0.150 TL
PKY-22040		2x4,00	12	17	8,0	11,1	4,2	200	0.358 TL
PKY-22060		2x6,00	14	20	9,5	12,1	5,3	100	0.430 TL
PKY-22100		2x10,00	14	27	12,6	12,6	6,9	50	0.806 TL
PKY-22160		2x16,00	14	31	19,0	19,0	8,7	25	1.125 TL



ÇİFT GİRİŞLİ İZOLELİ KABLO YÜKSÜKLERİ FRANSIZ NORMU

ÜRÜN KODU	RENK	KABLO KESİTİ	EBATLAR					KUTU ADETİ	LİSTE FİYATI
			[F]	[L]	[W]	[B]	[D]		
PKY-23005		2x0,50	8	14	5,0	6,5	1,8	1000	0.105 TL
PKY-23007		2x0,75	8	14	5,5	6,7	2,1	500	0.105 TL
PKY-23010		2x1,00	8	14	5,5	7,1	2,4	500	0.105 TL
PKY-23015		2x1,50	8	14	6,4	7,5	2,6	500	0.111 TL
PKY-23025		2x2,50	10	14	8,0	8,5	3,3	250	0.150 TL
PKY-23040		2x4,00	12	17	8,0	11,1	4,2	200	0.358 TL
PKY-23060		2x6,00	14	20	9,5	12,1	5,3	100	0.430 TL
PKY-23100		2x10,00	14	27	12,6	12,6	6,9	50	0.806 TL
PKY-23160		2x16,00	14	31	19,0	19,0	8,7	25	1.125 TL

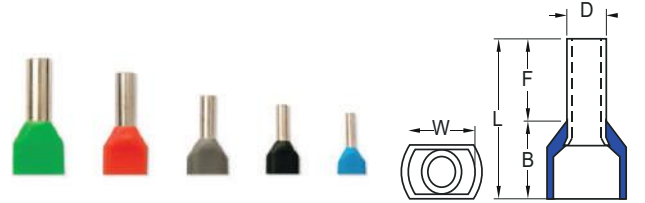

İZOLELİ KABLO UÇLARI

YUVARLAK TİP İZOLELİ KABLO UÇLARI

ÜRÜN KODU	KABLO KESİTİ	ÇİVATA ÖLÇÜSÜ	EBATLAR (mm)				KUTU ADETİ	LİSTE FİYATI
			[D2]	[I]	[D4]	[A]		
PYK-301	0,50-1,50mm	M3	3,2	16,0	4,0	10,0	200	0.137 TL
PYK-401	0,50-1,50mm	M4	4,3	17,0	4,0	10,0	200	0.189 TL
PYK-501	0,50-1,50mm	M5	5,3	18,0	4,0	10,0	200	0.202 TL
PYK-601	0,50-1,50mm	M6	6,5	18,0	4,0	10,0	200	0.255 TL
PYK-801	0,50-1,50mm	M8	8,4	22,0	4,0	10,0	200	0.275 TL



ÜRÜN KODU	KABLO KESİTİ	ÇİVATA ÖLÇÜSÜ	EBATLAR (mm)				KUTU ADETİ	LİSTE FİYATI
			[D2]	[I]	[D4]	[A]		
PYK-302	1,50-2,50mm	M3	3,2	16,0	4,5	10,0	200	0.195 TL
PYK-402	1,50-2,50mm	M4	4,3	17,0	4,5	10,0	200	0.221 TL
PYK-502	1,50-2,50mm	M5	5,3	19,0	4,5	10,0	200	0.247 TL
PYK-602	1,50-2,50mm	M6	6,5	21,0	4,5	10,0	200	0.280 TL
PYK-802	1,50-2,50mm	M8	8,4	22,0	4,5	10,0	200	0.306 TL
PYK-1002	1,50-2,50mm	M10	10,5	22,0	4,5	10,0	200	0.345 TL

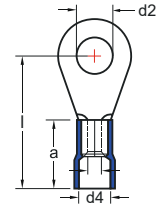

ÜRÜN KODU	KABLO KESİTİ	ÇİVATA ÖLÇÜSÜ	EBATLAR (mm)				KUTU ADETİ	LİSTE FİYATI
			[D2]	[I]	[D4]	[A]		
PYK-406	4,00-6,00mm	M4	4,3	21,0	6,3	13,0	100	0.403 TL
PYK-506	4,00-6,00mm	M5	5,3	22,0	6,3	13,0	100	0.410 TL
PYK-606	4,00-6,00mm	M6	6,5	22,5	6,3	13,0	100	0.475 TL
PYK-806	4,00-6,00mm	M8	8,4	26,0	6,3	13,0	100	0.592 TL
PYK-1006	4,00-6,00mm	M10	10,5	28,0	6,3	13,0	100	0.605 TL
PYK-1206	4,00-6,00mm	M12	13,0	28,0	6,3	13,0	100	0.715 TL

İZOLELİ KABLO UÇLARI

ÇATAL TİP İZOLELİ KABLO UÇLARI

ÜRÜN KODU	KABLO KESİTİ	CİVATA ÖLÇÜSÜ	EBATLAR (mm)				KUTU ADETİ	LİSTE FİYATI
			[D2]	[I]	[D4]	[A]		
PCK-301	0,50-1,50mm	M3	3,2	16,0	4,0	10,0	200	0.163 TL
PCK-401	0,50-1,50mm	M4	4,3	17,0	4,0	10,0	200	0.182 TL
PCK-501	0,50-1,50mm	M5	5,3	18,0	4,0	10,0	200	0.202 TL
PCK-601	0,50-1,50mm	M6	6,5	20,0	4,0	10,0	200	0.234 TL



ÜRÜN KODU	KABLO KESİTİ	CİVATA ÖLÇÜSÜ	EBATLAR (mm)				KUTU ADETİ	LİSTE FİYATI
			[D2]	[I]	[D4]	[A]		
PCK-302	1,50-2,50mm	M3	3,2	18,0	4,5	10,0	200	0.189 TL
PCK-402	1,50-2,50mm	M4	4,3	17,0	4,5	10,0	200	0.202 TL
PCK-502	1,50-2,50mm	M5	5,3	19,0	4,5	10,0	200	0.228 TL
PCK-602	1,50-2,50mm	M6	6,5	21,0	4,5	10,0	200	0.267 TL

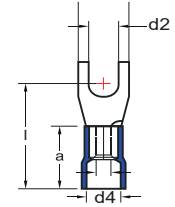

ÜRÜN KODU	KABLO KESİTİ	CİVATA ÖLÇÜSÜ	EBATLAR (mm)				KUTU ADETİ	LİSTE FİYATI
			[D2]	[I]	[D4]	[A]		
PCK-406	4,00-6,00mm	M4	8,4	22,0	4,5	10,0	100	0.364 TL
PCK-506	4,00-6,00mm	M5	10,5	22,0	4,5	10,0	100	0.370 TL
PCK-606	4,00-6,00mm	M6	13,0	25,0	4,5	10,0	100	0.468 TL
PCK-806	4,00-6,00mm	M8	4,0	21,0	6,3	13,0	100	0.618 TL



İZOLELİ KABLO UÇLARI

DİŞİ FASTON TİP İZOLELİ KABLO UÇLARI

ÜRÜN KODU	KABLO KESİTİ	SOKET GENİŞLİĞİ	EBATLAR (mm)					KUTU ADETİ	LİSTE FİYATI
			[W]	[F]	[L]	[E]	[D]		
PFD-1288	0,50-1,50mm	0,8x2,80	3,2	6,5	19,0	10,5	3,8	200	0.234 TL
PFD-1488	0,50-1,50mm	0,8x4,75	5	6,4	19,4	10,5	3,8	200	0.260 TL
PFD-1638	0,50-1,50mm	0,8x6,35	6,6	7,5	20,8	10,5	3,8	200	0.338 TL
PFD-2488	1,50-2,50mm	0,8x4,75	5	6,4	19,4	10,5	4,7	200	0.338 TL
PFD-2638	1,50-2,50mm	0,8x6,35	6,6	7,5	20,8	10,5	4,7	200	0.351 TL
PFD-5638	4,00-6,00mm	0,8x6,35	6,6	7,5	23,3	13,0	6,2	100	0.468 TL

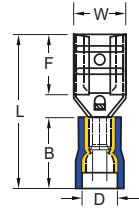

DİŞİ FASTON TİP TAM İZOLELİ KABLO UÇLARI

ÜRÜN KODU	KABLO KESİTİ	SOKET GENİŞLİĞİ	EBATLAR (mm)					KUTU ADETİ	LİSTE FİYATI
			[W]	[F]	[L]	[E]	[D]		
İPFD-1288	0,50-1,50mm	0,8x2,80	3,2	6,5	19,0	10,5	3,8	200	0.345 TL
İPFD-1488	0,50-1,50mm	0,8x4,75	5	6,4	19,4	10,5	3,8	200	0.345 TL
İPFD-1638	0,50-1,50mm	0,8x6,35	6,6	7,5	20,8	10,5	3,8	200	0.436 TL
İPFD-2488	1,50-2,50mm	0,8x4,75	5	6,4	19,4	10,5	4,7	200	0.371 TL
İPFD-2638	1,50-2,50mm	0,8x6,35	6,6	7,5	20,8	10,5	4,7	200	0.468 TL
İPFD-5638	4,00-6,00mm	0,8x6,35	6,6	7,5	23,3	13,0	6,2	100	0.546 TL

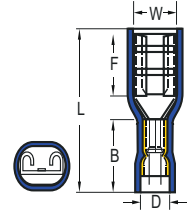

ERKEK FASTON TİP İZOLELİ KABLO UÇLARI

ÜRÜN KODU	KABLO KESİTİ	SOKET GENİŞLİĞİ	EBATLAR (mm)					KUTU ADETİ	LİSTE FİYATI
			[W]	[F]	[L]	[E]	[D]		
PFE-1288	0,50-1,50mm	0,8x2,80	2,8	6,5	19,2	10,5	3,8	200	0.260 TL
PFE-1488	0,50-1,50mm	0,8x4,75	4,8	6,7	19,8	10,5	3,8	200	0.260 TL
PFE-1638	0,50-1,50mm	0,8x6,35	6,35	7,7	21,8	10,5	3,8	200	0.300 TL
PFE-2488	1,50-2,50mm	0,8x4,75	4,8	6,7	19,8	10,5	4,7	200	0.260 TL
PFE-2638	1,50-2,50mm	0,8x6,35	6,35	7,7	21,8	10,5	4,7	200	0.300 TL
PFE-5638	4,00-6,00mm	0,8x6,35	6,35	7,7	24,0	13,0	6,2	100	0.423 TL

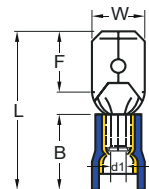

İZOLELİ KABLO UÇLARI

DİŞİ TERMİNALLER İZOLELİ KABLO UÇLARI

ÜRÜN KODU	KABLO KESİTİ	EBATLAR (mm)					KUTU ADETİ	LİSTE FİYATI
		[W]	[F]	[L]	[E]	[D]		
PFT-1040	0,50-1,50mm	3,9	7,0	23,3	10,5	3,8	200	0.533 TL
PFT-2050	1,50-2,50mm	4,9	7,0	23,3	10,5	4,7	100	0.605 TL
PFT-5050	4,00-6,00mm	4,9	7,0	25,1	12,5	6,2	100	0.813 TL

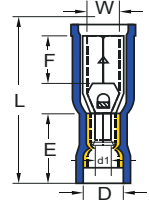

ERKEK TERMİNALLER İZOLELİ KABLO UÇLARI

ÜRÜN KODU	KABLO KESİTİ	EBATLAR (mm)					KUTU ADETİ	LİSTE FİYATI
		[W]	[F]	[L]	[E]	[D]		
PMT-1040	0,50-1,50mm	4,0	8,5	21,5	10,5	3,8	200	0.455 TL
PMT-2050	1,50-2,50mm	5,0	8,5	21,2	10,5	4,7	100	0.546 TL
PMT-5050	4,00-6,00mm	5,0	8,5	24,0	13,0	6,2	100	0.813 TL

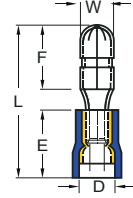

İĞNE TİP İZOLELİ KABLO UÇLARI

ÜRÜN KODU	KABLO KESİTİ	EBATLAR (mm)					KUTU ADETİ	LİSTE FİYATI
		[W]	[F]	[L]	[E]	[D]		
PKI-101	0,50-1,50mm	1,9	10,0	19,0	10,0	4,0	200	0.202 TL
PKI-102	1,50-2,50mm	1,9	12,0	21,8	10,0	4,5	200	0.208 TL
PKI-106	4,00-6,00mm	2,8	14,0	27,0	27,0	6,4	100	0.480 TL

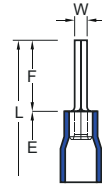

PBO SERİSİ BUTON VE AKSESUARLARI



 **plastim**[®]

PB0 SERİSİ 22mm BUTON VE SİNYALLER

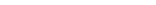

KOD	RENK	AÇIKLAMA	KONTAK	FİYAT
PB0-AA31		Yeşil Normal Buton Yeşil	1NO	12.50 TL
PB0-AA42		Kırmızı Normal Buton Kırmızı	1NC	12.50 TL
PB0-AA51		Sarı Normal Buton Sarı	1NO	12.50 TL
PB0-AA61		Mavi Normal Buton Mavi	1NO	12.50 TL
PB0-AA11		Beyaz Normal Buton Beyaz	1NO	12.50 TL
PB0-AA21		Siyah Normal Buton Siyah	1NO	12.50 TL
PB0-AA3341		Beyaz Oklu Buton Beyaz →	1NO	14.00 TL
PB0-AA3351		Siyah Oklu Buton Siyah →	1NO	14.00 TL
PB0-AA51L		Sarı Normal Buton Sarı Lamba İşaretli ☀	1NO	14.00 TL
PB0-AA610		Mavi Çift Yön Oklu Buton Mavi ↔	1NO	14.00 TL
PB0-AW31B5		Beyaz Işıklı Buton Beyaz LED 24V	1NO	25.00 TL
PB0-AW33B5		Yeşil Işıklı Buton Yeşil LED 24V	1NO	25.00 TL
PB0-AW34B5		Kırmızı Işıklı Buton Kırmızı LED 24V	1NC	25.00 TL
PB0-AW35B5		Sarı Işıklı Buton Sarı LED 24V	1NO	25.00 TL
PB0-AW36B5		Mavi Işıklı Buton Mavi LED 24V	1NO	25.00 TL
PB0-AW31M5		Beyaz Işıklı Buton Beyaz LED 220V	1NO	25.00 TL
PB0-AW33M5		Yeşil Işıklı Buton Yeşil LED 220V	1NO	25.00 TL
PB0-AW34M5		Kırmızı Işıklı Buton Kırmızı LED 220V	1NC	25.00 TL
PB0-AW35M5		Sarı Işıklı Buton Sarı LED 220V	1NO	25.00 TL
PB0-AW36M5		Mavi Işıklı Buton Mavi LED 220V	1NO	25.00 TL
PB0-AC42		Kırmızı Yaylı Mantar Buton Kırmızı	1NC	14.00 TL
PB0-AC31		Yeşil Yaylı Mantar Buton Yeşil	1NO	14.00 TL
PB0-AS542		Kırmızı Acil Stop Butonu	1NC	28.00 TL
PB0-AS542-24L		Kırmızı Acil Stop Butonu 24V LED	1NC	43.00 TL
PB0-AS542-230L		Kırmızı Acil Stop Butonu 220V LED	1NC	43.00 TL

PB0 SERİSİ 22mm BUTON VE SİNYALLER



KOD	RENK	AÇIKLAMA	KONTAK	FİYAT
PB0-AD21	■ Siyah	Kalıcı Mandal Buton 0-1 Siyah	1NO	13.50 TL
PB0-AD33	■ Siyah	Kalıcı Mandal Buton 1-0-2 Siyah	2NO	19.00 TL
PB0-AD53	■ Siyah	Yaylı Mandal Buton 1-0-2 Siyah	2NO	22.00 TL
PB0-AD41	■ Siyah	Yaylı Mandal Buton 0-1 Siyah	1NO	16.00 TL
PB0-AJ21	■ Siyah	Kalıcı Mandal Buton 0-1 Siyah Uzun Mandal	1NO	14.50 TL
PB0-AJ33	■ Siyah	Kalıcı Mandal Buton 1-0-2 Siyah Uzun Mandal	2NO	20.00 TL
PB0-AJ53	■ Siyah	Yaylı Mandal Buton 1-0-2 Siyah Uzun Mandal	2NO	23.00 TL
PB0-AK123B5	■ Yeşil	Işıklı Mandal Buton 0-1 Yeşil LED 24V	1NO	30.00 TL
PB0-AK124B5	■ Kırmızı	Işıklı Mandal Buton 0-1 Kırmızı LED 24V	1NC	30.00 TL
PB0-AK125B5	■ Sarı	Işıklı Mandal Buton 0-1 Sarı LED 24V	1NO	30.00 TL
PB0-AK123M5	■ Yeşil	Işıklı Mandal Buton 0-1 Yeşil LED 220V	1NO	30.00 TL
PB0-AK124M5	■ Kırmızı	Işıklı Mandal Buton 0-1 Kırmızı LED 220V	1NC	30.00 TL
PB0-AK125M5	■ Sarı	Işıklı Mandal Buton 0-1 Sarı LED 220V	1NO	30.00 TL
PB0-AK133B5	■ Yeşil	Işıklı Mandal Buton 1-0-2 Yeşil LED 24V	2NO	35.00 TL
PB0-AK134B5	■ Kırmızı	Işıklı Mandal Buton 1-0-2 Kırmızı LED 24V	2NC	35.00 TL
PB0-AK135B5	■ Sarı	Işıklı Mandal Buton 1-0-2 Sarı LED 24V	2NO	35.00 TL
PB0-AK133M5	■ Yeşil	Işıklı Mandal Buton 1-0-2 Yeşil LED 220V	2NO	35.00 TL
PB0-AK134M5	■ Kırmızı	Işıklı Mandal Buton 1-0-2 Kırmızı LED 220V	2NC	35.00 TL
PB0-AK135M5	■ Sarı	Işıklı Mandal Buton 1-0-2 Sarı LED 220V	2NO	35.00 TL
PB0-AG21	■ Siyah	Anahtarlı Mandal Buton Kalıcı 0-1	1NO	30.00 TL
PB0-AG33	■ Siyah	Anahtarlı Mandal Buton Kalıcı 1-0-2	2NO	35.00 TL
PB0-AG21-P	■ Siyah	Anahtarlı Mandal Buton Kalıcı 0-1	1NO	30.00 TL
PB0-AG33-P	■ Siyah	Anahtarlı Mandal Buton Kalıcı 1-0-2	2NO	35.00 TL

P= Anahtar her konumda çıkartılabilen model.

PB0 SERİSİ 22mm BUTON VE SİNYALLER



KOD	RENK	AÇIKLAMA	KONTAK	FİYAT
PB0-AL73415	Kırmızı+Yeşil	İkiz Buton	1NO+1NC	23.00 TL
PB0-AW734B5	Kırmızı+Yeşil	Işıklı İkiz Buton LED 24V	1NO+1NC	34.00 TL
PB0-AW734M5	Kırmızı+Yeşil	Işıklı İkiz Buton LED 220V	1NO+1NC	34.00 TL
PB0-LS22-24R	Kırmızı	LED Sinyal 22mm Kırmızı 24VAC-DC	- -	5.20 TL
PB0-LS22-24G	Yeşil	LED Sinyal 22mm Yeşil 24VAC-DC	- -	5.20 TL
PB0-LS22-24Y	Sarı	LED Sinyal 22mm Sarı 24VAC-DC	- -	5.20 TL
PB0-LS22-24W	Beyaz	LED Sinyal 22mm Beyaz 24VAC-DC	- -	6.10 TL
PB0-LS22-24B	Mavi	LED Sinyal 22mm Mavi 24VAC-DC	- -	6.10 TL
PB0-LS22-220R	Kırmızı	LED Sinyal 22mm Kırmızı 220VAC	- -	5.20 TL
PB0-LS22-220G	Yeşil	LED Sinyal 22mm Yeşil 220VAC	- -	5.20 TL
PB0-LS22-220Y	Sarı	LED Sinyal 22mm Sarı 220VAC	- -	5.20 TL
PB0-LS22-220W	Beyaz	LED Sinyal 22mm Beyaz 220VAC	- -	6.10 TL
PB0-LS22-220B	Mavi	LED Sinyal 22mm Mavi 220VAC	- -	6.10 TL
PB0-B22-24	Siyah	Buzzer 24VAC-DC	- -	24.00 TL
PB0-B22-220	Siyah	Buzzer 220VAC-DC	- -	24.00 TL
PB0-LB22-24R	Kırmızı	Işıklı Buzzer 24VAC-DC	- -	26.00 TL
PB0-LB22-220R	Kırmızı	Işıklı Buzzer 220VAC-DC	- -	26.00 TL
PB0-LS22-220RG	Kırmızı+Yeşil	Çift Renk Sinyal Kırmızı-Yeşil 220VAC	- -	16.00 TL
PB0-LS22-24RG	Kırmızı+Yeşil	Çift Renk Sinyal Kırmızı-Yeşil 24VAC-DC	- -	16.00 TL
PB0-POT-1K	Siyah	Tek Tur Potansiyometre 1K Ohm (Ω)	- -	12.00 €
PB0-POT-2.5K	Siyah	Tek Tur Potansiyometre 2.5K Ohm (Ω)	- -	12.00 €
PB0-POT-5K	Siyah	Tek Tur Potansiyometre 5K Ohm (Ω)	- -	12.00 €
PB0-POT-10K	Siyah	Tek Tur Potansiyometre 10K Ohm (Ω)	- -	12.00 €

PB0 SERİSİ 22mm BUTON VE SİNYAL AKSESUARLARI



KOD	RENK	AÇIKLAMA	KONTAK	FİYAT
PB-BK 01Y	Sarı-Siyah	Buton Kutusu 1li Sarı-Siyah	- -	14.60 TL
PB-BK 01G	Gri-Siyah	Buton Kutusu 1li Gri-Siyah	- -	14.60 TL
PB-BK 02G	Gri-Siyah	Buton Kutusu 2li Gri-Siyah	- -	19.50 TL
PB-BK 03G	Gri-Siyah	Buton Kutusu 3lü Gri-Siyah	- -	24.30 TL
PB-BK 04G	Gri-Siyah	Buton Kutusu 4lü Gri-Siyah	- -	35.00 TL
PB-BK 05G	Gri-Siyah	Buton Kutusu 5li Gri-Siyah	- -	48.80 TL



PB0-KB01	NC Kontak	NC Kontak	1NC	6.50 TL
PB0-KB10	NO Kontak	NO Kontak	1NO	6.50 TL



PB0-A-M5		Buton LED kontak 220VAC	- -	13.00 TL
PB0-A-B5		Buton LED kontak 24VAC-DC	- -	13.00 TL

PB-SB22	Silikon Buton Koruma Başlığı 22mm Şeffaf	- -	4.50 TL
PB-BSA	Buton Somunu Sıkma Aparatı	- -	16.30 TL
PB-ES60	Acil Stop Etiket 60mm	- -	5.20 TL
PB-ES90	Acil Stop Etiket 90mm	- -	5.50 TL
PB-BR2515	Buton Rozeti 25x15mm	- -	1.65 TL
PB-KT22	Kör Tapa+Somun 22mm	- -	3.25 TL
PB-BKO	Buton Koruma Kapağı Oval	- -	5.20 TL
PB-BKY	Buton Koruma Kapağı Yuvarlak	- -	5.20 TL



PB-SB22



PB-BSA



PB-ES60



PB-BR2515



PB-KT22



PB-BKO



PB-BKY

MEKANİK ve HİDROLİK EL ALETLERİ

P-VSC8 6-4C

125.00 \$



0,08-10 mm² Yüksük Sıkma Pensesi 4 Köşe



P-VSC8 6-6A

145.00 \$



0,08-6 mm² Yüksük Sıkma Pensesi 6 Köşe



P-VSC11 16-4A

215.00 \$



0,08-16 mm² Yüksük Sıkma Pensesi 4 Köşe



P-VSC12 16-6A

300.00 \$



0,08-16 mm² Yüksük Sıkma Pensesi 6 Köşe



P-VSC10 16-4A

210.00 \$



0,08-16 mm² Yüksük Sıkma Pensesi 4 Köşe



P-VSN-10WF

125.00 \$



0,25-10 mm² Yüksük Sıkma Pensesi



P-VSN-30J

120.00 \$



0,5-6 mm² İzoleli Kablo Ucu Sıkma Pensesi



P-HS 700D

26.00 \$



0,50-6 mm² Kablo Sıyrma Pensesi

P-VSQ-70SC

200.00 \$



6-70 mm² SKP Sıkma Pensesi



P-VSQ-120B

300.00 \$



10-120 mm² SKP Sıkma Pensesi



MEKANİK ve HİDROLİK EL ALETLERİ

P-VSQ-150SC

325.00 \$



25-150 mm² SKP Sıkma Pensesi



P-HX-50SC

66.00 \$

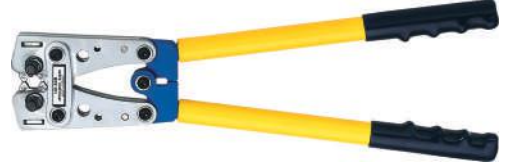

6-50 mm² SKP Sıkma Pensesi



P-HX-120SC

135.00 \$



10-120 mm² SKP Sıkma Pensesi



P-HX-150SC

140.00 \$



25-150 mm² SKP Sıkma Pensesi



P-YQK-300

150.00 \$



16-300 mm² Hidrolikli SKP Sıkma Pensesi (çantalı set)



P-LK-22

22.00 \$



25 mm² Kablo Kesme Makası

P-LK-38

25.00 \$

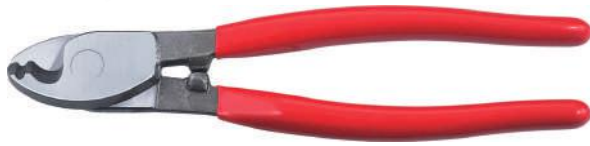

50 mm² Kablo Kesme Makası

P-LK-60

33.00 \$



60 mm² Kablo Kesme Makası

P-HJ 130

58.00 \$



120 mm² Kablo Kesme Makası

P-VC-150G

90.00 \$



150 mm² Kablo Kesme Makası

MEKANİK ve HİDROLİK EL ALETLERİ

P-VC-300G

107.00 \$



300 mm² Kablo Kesme Makası

P-VC-500G

165.00 \$



500 mm² Kablo Kesme Makası

PDC250

6.825.00 TL



Masa Tipi Kanal Kesme Makası

PRKM35

5.200.00 TL

DIN Rayı Kesme Makası 35x7.5mm² ve 35x15mm² için

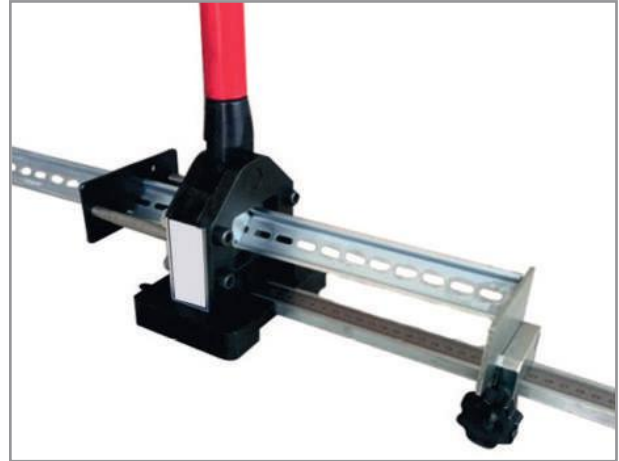

ALÜMİNYUM PRİZ BLOKLARI

- 2 modül = 1 priz
- Telefon uydu,internet, açma-kapama düğmesi takılabilir.



ÜRÜN KODU	ÖLÇÜLER (mm) (En x Boy x Derinlik)	ÜRÜN ÖZELLİKLERİ	FİYAT
PGP-04B	65x142x50	4 Modül - 2 Priz	36.00 TL
PGP-06B	65x187x50	6 Modül - 3 Priz	39.00 TL
PGP-08B	65x232x50	8 Modül - 4 Priz	47.00 TL
PGP-10B	65x277x50	10 Modül - 5 Priz	55.00 TL
PGP-12B	65x322x50	12 Modül - 6 Priz	61.00 TL
PGP-14B	65x365x50	14 Modül - 7 Priz	78.00 TL
PGP-16B	65x412x50	16 Modül - 8 Priz	83.00 TL



ÜRÜN KODU	ÖLÇÜLER (mm)	ÜRÜN ÖZELLİKLERİ	FİYAT
PG-TPR-W	45x45	Beyaz Topraklı Priz Çocuk Korumalı	8.40 TL
PG-TPR-B	45x45	Siyah Topraklı Priz Çocuk Korumalı	8.90 TL
PG-UPS-R	45x45	Kırmızı UPS Prizi Çocuk Korumalı	9.10 TL

NOTLAR

A series of horizontal dashed lines for writing notes.

NOTLAR

A series of horizontal dashed lines for writing notes.



Plastim üretiminde daima
en yüksek teknolojiyi kullanmaktadır.

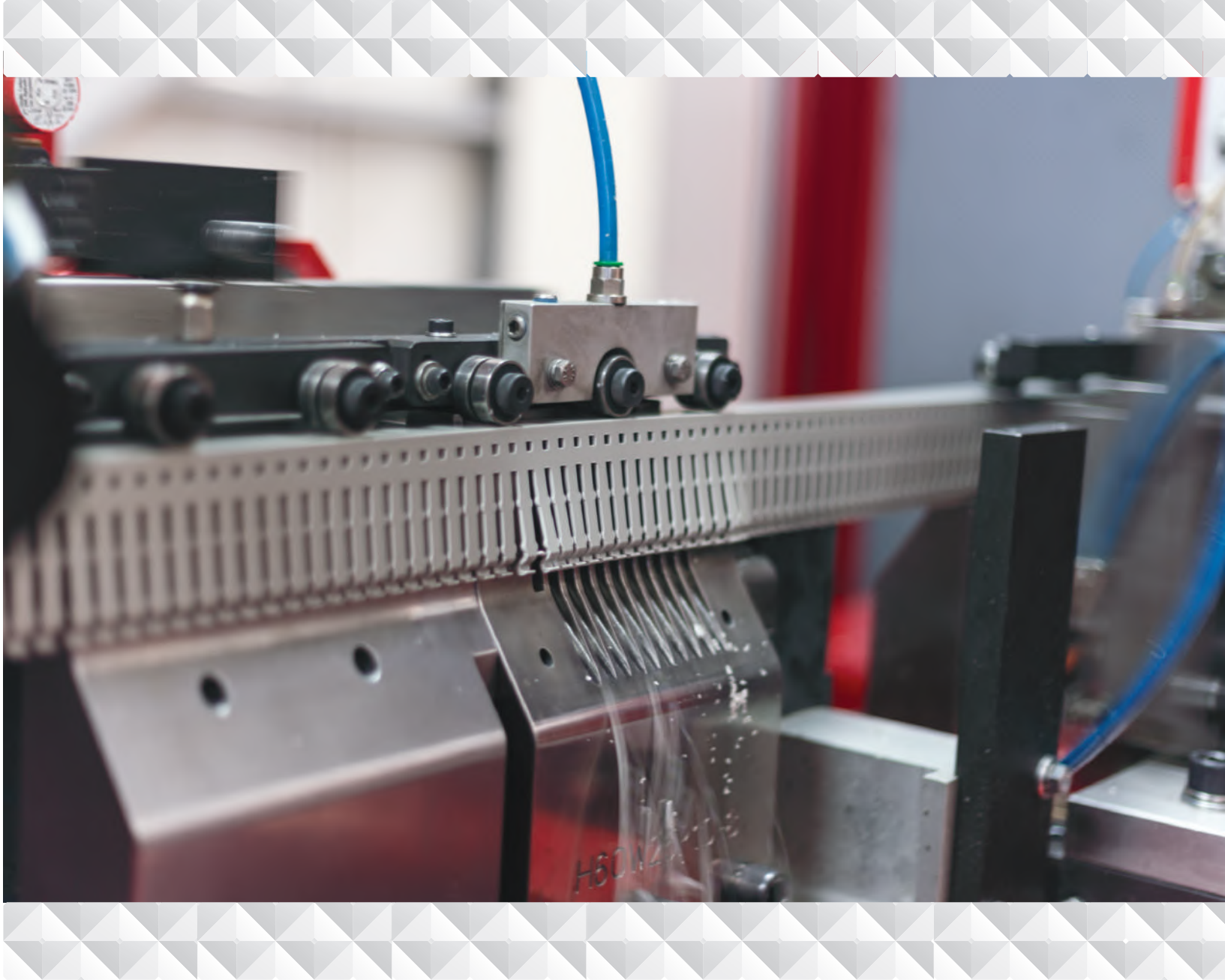

Dünyanın en *hızlı*
delikli kablo kanalı
üretim hattı (10mt/dk)



PLASTİM ELEKTRİK MALZEMELERİ İMALAT SAN.TİC.LTD.ŞTİ

MERKEZ: Perpa Elektrokent A Blok Kat: 2 No: 37 34384 Okmeydanı - İstanbul / Türkiye
Tel: +90 212 210 17 10 Faks: +90 212 221 72 37 E-Posta: info@plastim.com.tr

FABRİKA 1: Alipaşa Mahallesi Boztepe Sokak No: 5 34570 Silivri - İstanbul / Türkiye

FABRİKA 2: İkitelli OSB Fatih Sanayi Sitesi 4A Blok No: 3-4 34306 Başakşehir / İstanbul / Türkiye

MARMARA ve TRAKYA: MARMARA TİM ELEKTRİK OTOM.SAN VE TİC.LTD.ŞTİ

Perpa Elektrokent A Blok Kat: 2 No: 37 34384 Okmeydanı - İstanbul / Türkiye
Tel: +90 212 210 17 10 Faks: +90 212 221 72 37 E-Posta: info@marmaratim.com.tr

GÜNEY MARMARA: BURSA TİM ELEKTRİK OTOM.SAN VE TİC.LTD.ŞTİ

Alaaddinbey Mahallesi, 70. Sokak No: 14/C 16120 Nilüfer / Bursa / Türkiye
Tel: +90 224 443 38 46 Faks: +90 224 443 38 47 E-posta: info@bursatim.com.tr

İÇ ANADOLU D.ANADOLU KARADENİZ: ANADOLU TİM ELEKTRİK OTOM.SAN VE TİC.LTD.ŞTİ

İvedik Organize Sanayi Bölgesi 1354. Cadde 1387 Sokak No: 20 06378 Yenimahalle / Ankara / Türkiye
Tel: +90 312 394 03 35 Faks: +90 312 394 03 36 E-posta: info@anadolutim.com.tr

EGE AKDENİZ: PLASTİM EGE ELEKTRİK ENERJİ OTOM.SAN VE TİC.LTD.ŞTİ

Meriç Mahallesi 5746/10 Sokak No:11 35090 Bornova / İzmir / Türkiye
Tel: +90 232 360 11 11 Faks: +90 232 360 10 01 E-posta: info@plastimege.com.tr

**TÜRKİYE'DEN
DÜNYANIN DÖRT BİR YANINA!**

- ALGERIA
- AUSTRALIA
- AZERBAIJAN
- BOSNIA HERZEGOVINA
- BULGARIA
- COLOMBIA
- CZECH REPUBLIC
- CROATIA
- EGYPT
- ENGLAND
- ECUADOR
- FINLAND
- GERMANY
- GREECE
- HONDURAS
- HUNGARY
- ICELAND
- INDONESIA
- IRAQ
- IRAN
- IRELAND
- ISRAEL
- ITALY
- JORDAN
- KUWAIT
- LATVIA
- LITHUANIA
- LEBANON
- LIBYA
- MOROCCO
- MALDIVES
- MEXICO
- NETHERLAND
- NIGERIA
- PALESTINE
- PAKISTAN
- PERU
- POLAND
- PORTUGAL
- QATAR
- ROMANIA
- RUSSIA
- SAUDI ARABIA
- SERBIA
- SINGAPORE
- SPAIN
- SOUTH AFRICA
- SRI LANKA
- SWITZERLAND
- TAIWAN
- THAILAND
- TUNISIA
- UKRAINE
- UAE
- USA
- VIETNAM